

PM45 / PM45C INDUSTRIAL PRINTER

Configuration Guide



PM45C SHORT DOOR



PM45C LONG DOOR



PM45C MEGA DOME DOOR



PM45

THE
FUTURE
IS
WHAT
WE
MAKE IT

Honeywell

TABLE OF CONTENTS

- 1 TABLE OF CONTENTS**
- 2 PM45 PRINTING OPTIONS**
- 3 PM45 MEDIA**
 - SPECIFICATIONS
 - FIXED MEDIA HANGER VS ROTATING MEDIA HANGER
 - FULL BATCH REWINDER
- 6 PM45 FEATURE OVERVIEW**
 - TEAR OFF
 - FULL TOUCH DISPLAY - THERMAL TRANSFER
 - FULL TOUCH DISPLAY - THERMAL TRANSFER - WIFI/ BLUETOOTH (ROW)
 - FULL TOUCH DISPLAY - THERMAL TRANSFER - WIFI/ BLUETOOTH (NA)
 - ICON DISPLAY - THERMAL TRANSFER
 - ICON DISPLAY - DIRECT THERMAL
 - REWINDER + LABEL TAKEN SENSOR
 - FULL TOUCH DISPLAY - THERMAL TRANSFER
 - FULL TOUCH DISPLAY - **PARALLEL INTERFACE** - THERMAL TRANSFER
 - FULL TOUCH DISPLAY - **INDUSTRIAL INTERFACE** - THERMAL TRANSFER
 - FULL TOUCH DISPLAY - **APPLICATOR INTERFACE** - THERMAL TRANSFER
 - FULL TOUCH DISPLAY - THERMAL TRANSFER - **RFID (EU)**
 - FULL TOUCH DISPLAY - THERMAL TRANSFER - WIFI/ BLUETOOTH (NA) - WWAN - **RFID (NA)**
- 17 PM45G FEATURE OVERVIEW**
 - REWINDER + LABEL TAKEN SENSOR
 - FULL TOUCH DISPLAY - PARALLEL INTERFACE - THERMAL TRANSFER
 - FULL BATCH REWINDER + LABEL TAKEN SENSOR
 - FULL TOUCH DISPLAY - PARALLEL INTERFACE - THERMAL TRANSFER
- 19 PM45 CONFIGURATION MAP**
 - INDUSTRIAL PRINTER
- 20 PM45C PRINTING OPTIONS**
- 21 PM45C MEDIA**
 - SPECIFICATIONS
 - RIBBON REWINDER CAPACITY
 - SHORT DOOR, LONG DOOR AND MEGA DOME DOOR LABEL CAPACITY
- 24 PM45C SHORT DOOR FEATURE OVERVIEW**
 - TEAR OFF
 - FULL TOUCH DISPLAY - THERMAL TRANSFER
 - REWINDER + LABEL TAKEN SENSOR
 - FULL TOUCH DISPLAY - THERMAL TRANSFER
- 26 PM45C LONG DOOR FEATURE OVERVIEW**
 - TEAR OFF
 - FULL TOUCH DISPLAY - THERMAL TRANSFER
 - ICON DISPLAY - THERMAL TRANSFER
 - ICON DISPLAY - DIRECT THERMAL
 - REWINDER + LABEL TAKEN SENSOR
 - FULL TOUCH DISPLAY - DIRECT THERMAL
 - FULL TOUCH DISPLAY - DIRECT THERMAL - WIFI/ BLUETOOTH (ROW)
 - FULL TOUCH DISPLAY - THERMAL TRANSFER
 - ICON DISPLAY - THERMAL TRANSFER
- 33 PM45C MEGA DOME DOOR FEATURE OVERVIEW**
 - TEAR OFF
 - FULL TOUCH DISPLAY - THERMAL TRANSFER
 - ICON DISPLAY - THERMAL TRANSFER
 - REWINDER + LABEL TAKEN SENSOR
 - FULL TOUCH DISPLAY - THERMAL TRANSFER
- 36 PM45C CONFIGURATION MAP**
 - COMPACT INDUSTRIAL PRINTER
- 37 HONEYWELL EDGE SERVICES**
 - GOLD REPAIR SERVICES - 3 YEAR
 - PLATINUM REPAIR SERVICES - 3 YEAR
 - GOLD REPAIR SERVICES - 5 YEAR
 - PLATINUM REPAIR SERVICES - 5 YEAR
 - PM45/ PM45C- REPAIR SERVICES COVERAGE
- 40 ACCESSORIES**
 - PM45/ PM45C - I/O CARDS
 - PM45/ PM45C - WIFI AND BLUETOOTH CARD
 - PM45/ PM45C - WWAN 4G LTE - CELLULAR MODEM
 - PM45 CUTTER
 - PM45C CUTTER
 - PM45/ PM45C ROTATION HANGER
 - SERVICE UPGRADE KIT - INTERNAL REWINDER + LABEL TAKEN SENSOR
 - PM45 FULL BATCH REWINDER
 - CONSUMABLES AND CABLES
- 48 MISCELLANEOUS**
 - AC CORDS
- 49 APPENDIX**
 - PM45 VS PM43 ACCESSORIES
 - FRONT DISPLAY - COMPARE PM45 TO PM43
 - MEDIA COMPARTMENT - COMPARE PM45 TO PM43
 - CONNECTIVITY - COMPARE PM45 TO PM43

PM45 PRINTING OPTIONS



Tear Off

Most commonly used, print any number of labels and simply tear the labels off from the printer at the end of the print job. This method of printing is available on any PM45 configuration.



Cutter

A cutter can be added to any configuration of PM45, simply cutting between labels, or at intervals on continuous media. This method of printing is available on any PM45 configuration.



Full Batch Rewinder

The Full Batch Rewinder accessory can rewind a full of 8" media roll. The accessory comes with a bottom extended enclosure, internal rewind mechanism and a cut out base.



Peel & Present (Standard Self-Strip using Tear Bar)

Self-Strip prints and presents only one label at a time already peeled from the backing strip/ liner, the next label will only be printed once the original label is removed from the media path. Not applicable for all media types, use Peel Off Kit for best results.
PM45Axxxxx3xxxx PM45 with Internal Rewind + LTS



Peel & Present (Enhanced Self-Strip with Peel Off Kit)

Self-Strip prints and presents only one label at a time already peeled from the backing strip/ liner, the next label will only be printed once the original label is removed from the media path.
PM45Axxxxx3xxxx PM45 with Internal Rewind + LTS
50180196-001 Label Dispenser kit



Batch Plate with Internal Rewinder

The Batch Plate with Internal Rewinder is used to pre-print labels and rewind them inside the PM45. Depending on the label size up to 1/3 of a full roll can be stored inside the PM45. For full roll to roll batch printing use the Full Batch Rewinder.
PM45Axxxxx3xxxx PM45 with Internal Rewind + LTS

ID = Inside Diameter
OD = Outside Diameter

PM45 MEDIA

Specifications

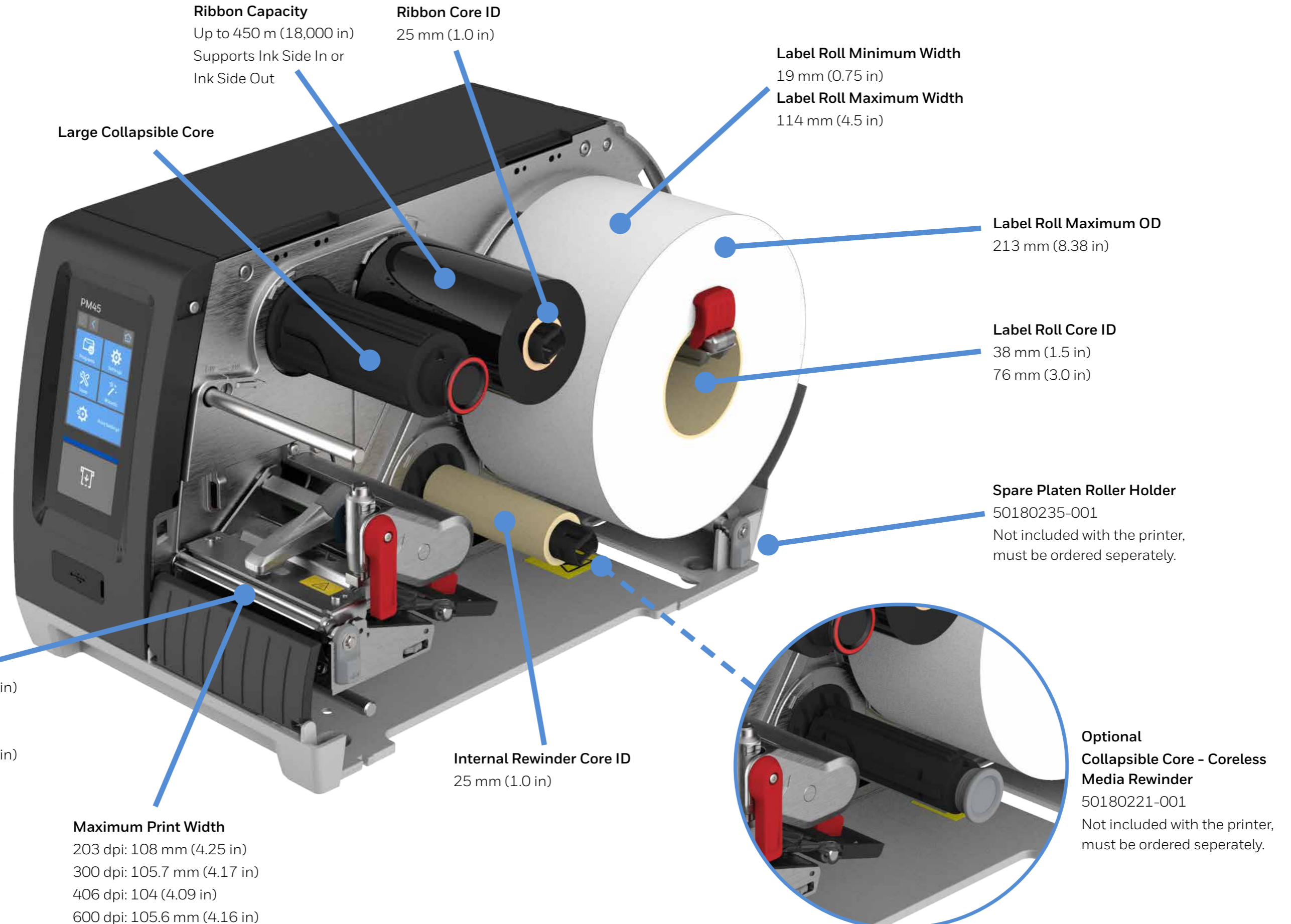

Ribbon Capacity
Up to 450 m (18,000 in)
Supports Ink Side In or
Ink Side Out

Ribbon Core ID
25 mm (1.0 in)

Label Roll Minimum Width
19 mm (0.75 in)
Label Roll Maximum Width
114 mm (4.5 in)

Large Collapsible Core

Label Roll Maximum OD
213 mm (8.38 in)

Label Roll Core ID
38 mm (1.5 in)
76 mm (3.0 in)

Spare Platen Roller Holder
50180235-001
Not included with the printer,
must be ordered separately.

Minimum Label Length

Tear Off	6.35 mm (0.25 in)
Peel-Off Kit	25 mm (1.0 in)
Cutter	25 mm (1.0 in)
Rewind	6.35 mm (0.25 in)
RFID	25 mm (1.0 in)

Internal Rewinder Core ID
25 mm (1.0 in)

Maximum Print Width
203 dpi: 108 mm (4.25 in)
300 dpi: 105.7 mm (4.17 in)
406 dpi: 104 (4.09 in)
600 dpi: 105.6 mm (4.16 in)

Optional Collapsible Core - Coreless Media Rewinder
50180221-001
Not included with the printer,
must be ordered separately.

ID = Inside Diameter
OD = Outside Diameter

PM45 MEDIA

Fixed Media Hanger vs Rotating Media Hanger

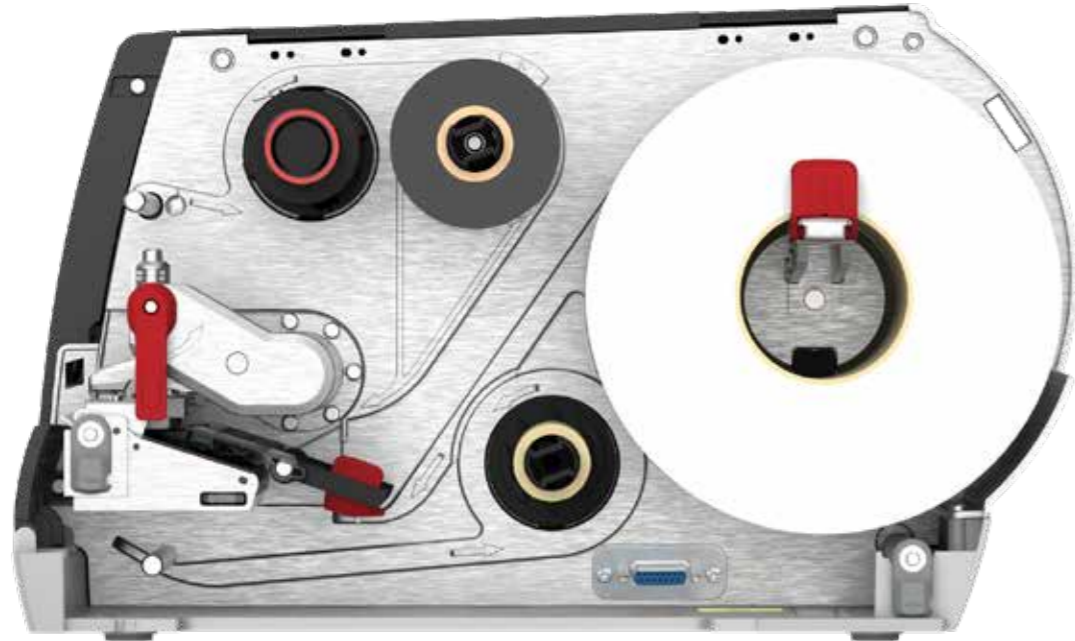

Fixed Media Hanger + Label Roll Core 76 mm (3.0 in) ID
Shown with Label Roll 213 mm (8.38 in) OD
Typical length of material with typical thickness of labels ~ 195 m



Rotating Media Hanger + Label Roll Core 76 mm (3.0 in) ID
Shown with Label Roll 213 mm (8.38 in) OD
Typical length of material with typical thickness of labels ~ 195 m



Fixed Media Hanger + Label Roll Core 38 mm (1.5 in) ID
Shown with Label Roll 213 mm (8.38 in) OD
Typical length of material with typical thickness of labels ~ 220 m



Rotating Media Hanger + Label Roll Core 38 mm (1.5 in) ID
Shown with Label Roll 213 mm (8.38 in) OD
Typical length of material with typical thickness of labels ~ 220 m

ID = Inside Diameter
OD = Outside Diameter

PM45 MEDIA

Full Batch Rewinder

**Optional
Collapsible Core - Coreless
Media Rewinder**
50180221-001
Not included with the printer,
must be ordered separately.



Full Batch Rewinder Core ID
25 mm (1.0 in)

Fixed Media Hanger + Label Roll Core 38 mm (1.5 in) ID
Media Supply: Shown with Label Roll 213 mm (8.38 in) OD
Typical length of material with typical thickness of labels ~ 220 m

Media Rewinder: Shown with Label Roll 213 mm (8.38 in) OD

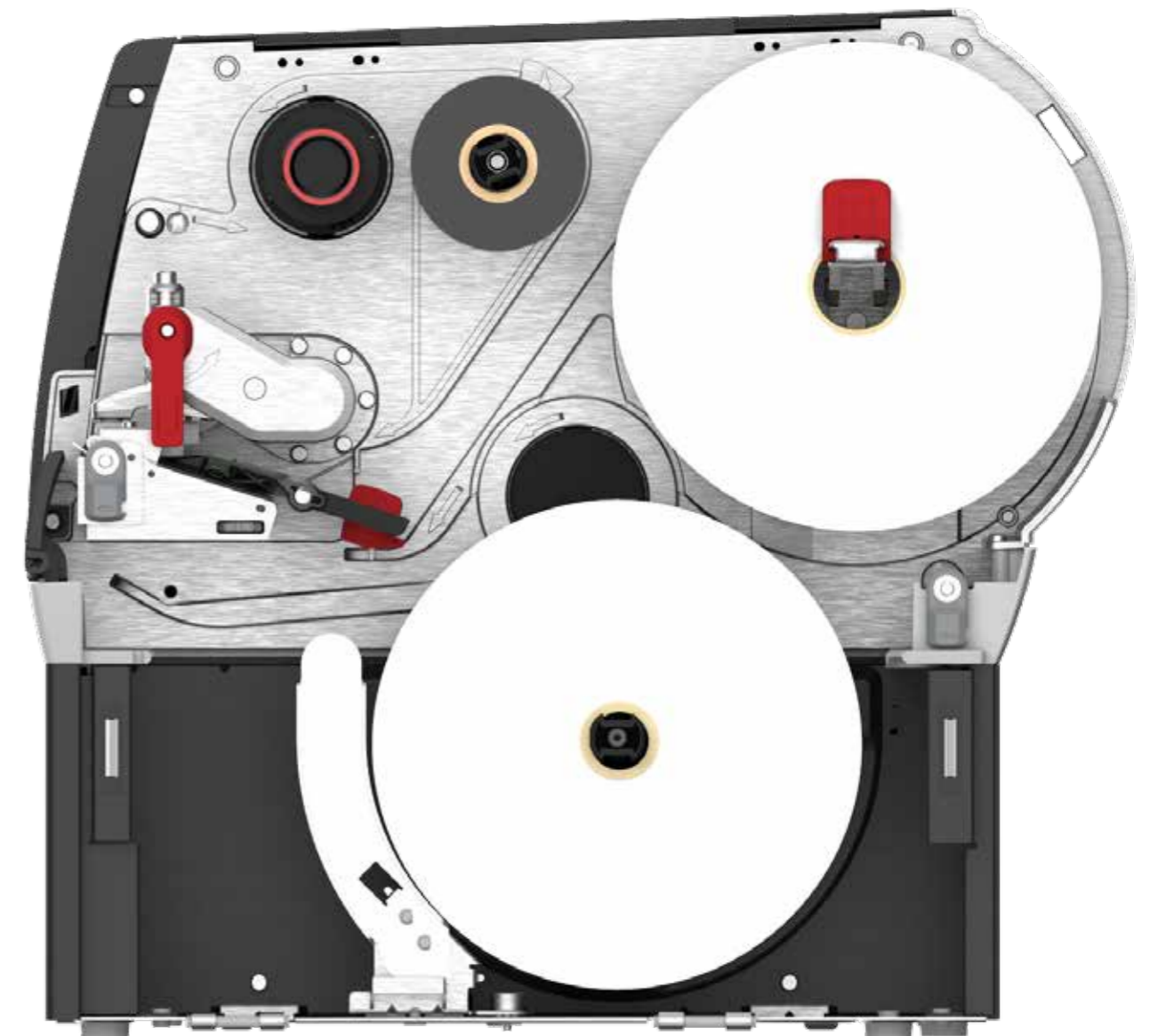

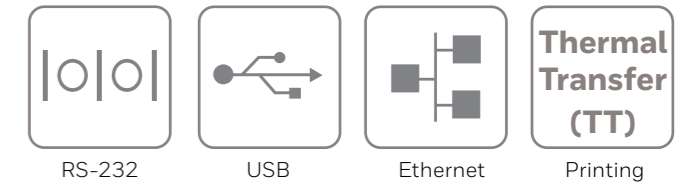

PM45 FEATURE OVERVIEW

Tear Off - Full Touch Display - Thermal Transfer

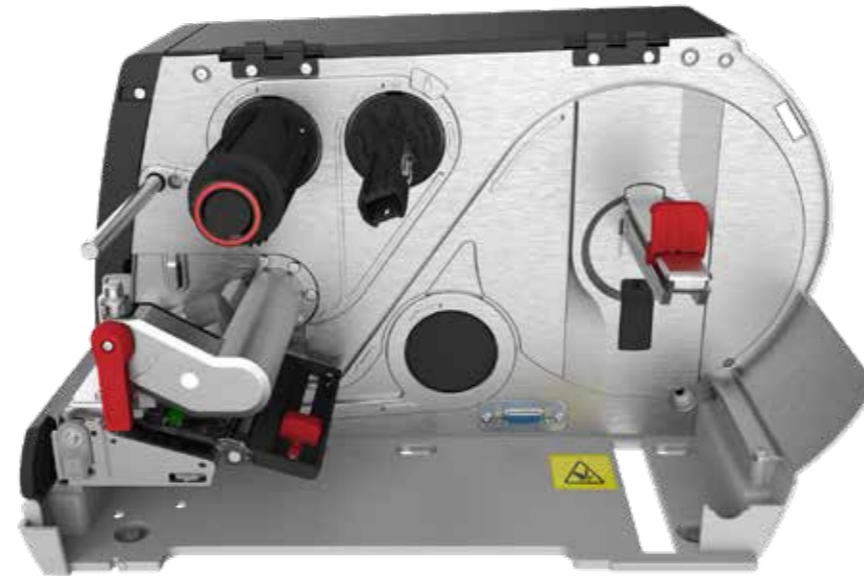

PM45A - Full Touch - Thermal Transfer - 203 DPI

PM45A10000000200 PM45A, Full Touch Display, Ethernet, Fixed Hanger, Real Time Clock (RTC), Thermal Transfer (TT), 203 DPI, No Power Cord

PM45A - Full Touch - Thermal Transfer - 300 DPI

PM45A10000000300 PM45A, Full Touch Display, Ethernet, Fixed Hanger, Real Time Clock (RTC), Thermal Transfer (TT), 300 DPI, No Power Cord

PM45A - Full Touch - Thermal Transfer - 406 DPI

PM45A10000000400 PM45A, Full Touch Display, Ethernet, Fixed Hanger, Real Time Clock (RTC), Thermal Transfer (TT), 406 DPI, No Power Cord

PM45A - Full Touch - Thermal Transfer - 600 DPI

PM45A10000000600 PM45A, Full Touch Display, Ethernet, Fixed Hanger, Real Time Clock (RTC), Thermal Transfer (TT), 600 DPI, No Power Cord

Included in the box:

- PM45A
- PM45 Regulatory Sheet (PM45-ML-RS-01)
- Collapsible Core



- No Power Cord

Note: Not all printer combinations are available in every region. Check your local Price Book to see which part numbers are available for sale.

Honeywell Repair Services

SVC PM45-SG3N	PM45 / PM45C, Edge Service, Gold Maintenance Contract, 3 Year, New Contract
ADD SVCPRINTHEAD-PRN3	AddOn, Edge Service, Printhead Refresh Service, 203 or 300 DPI, 3-Year Contract
ADD SVCACC-PRN3	AddOn, Edge Service, Accessory Service, Printer, 3 Year

PM45 FEATURE OVERVIEW

Tear Off - Full Touch Display - Thermal Transfer - WiFi/ Bluetooth (ROW)

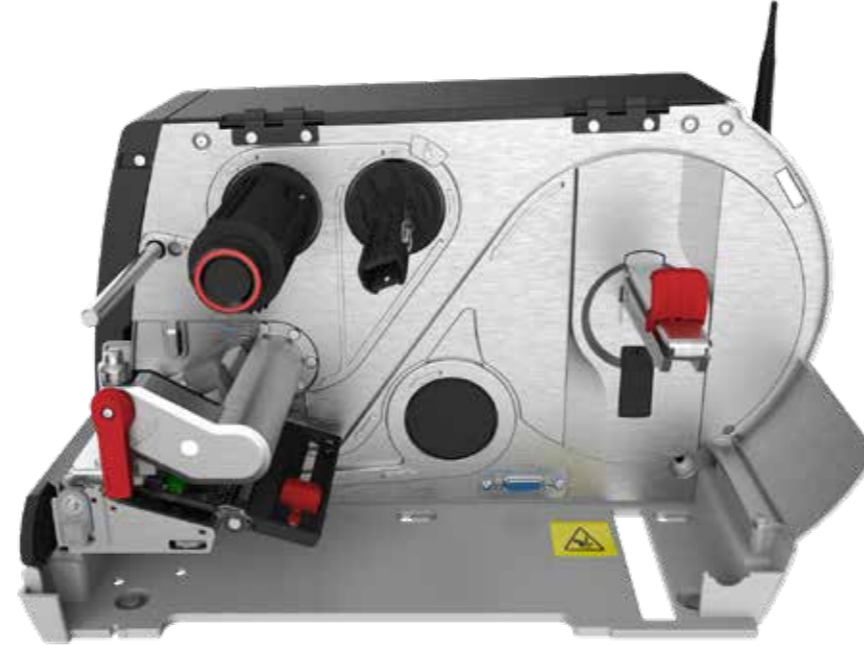
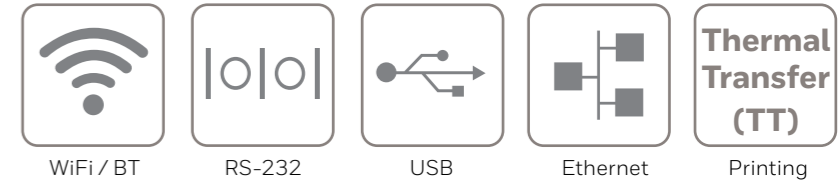

PM45A - Full Touch - WiFi/ Bluetooth (ROW) - Thermal Transfer - 203 DPI

PM45A12000000200 PM45A, Full Touch Display, Ethernet, Bluetooth V5.0, WiFi Rest of World (ROW) IEEE 802.11 a/b/g/n/ac, Fixed Hanger, Real Time Clock (RTC), Thermal Transfer (TT), 203 DPI, No Power Cord

PM45A - Full Touch - WiFi/ Bluetooth (ROW) - Thermal Transfer - 300 DPI

PM45A12000000300 PM45A, Full Touch Display, Ethernet, Bluetooth V5.0, WiFi Rest of World (ROW) IEEE 802.11 a/b/g/n/ac, Fixed Hanger, Real Time Clock (RTC), Thermal Transfer (TT), 300 DPI, No Power Cord

PM45A - Full Touch - WiFi/ Bluetooth (ROW) - Thermal Transfer - 406 DPI

PM45A12000000400 PM45A, Full Touch Display, Ethernet, Bluetooth V5.0, WiFi Rest of World (ROW) IEEE 802.11 a/b/g/n/ac, Fixed Hanger, Real Time Clock (RTC), Thermal Transfer (TT), 406 DPI, No Power Cord

PM45A - Full Touch - WiFi/ Bluetooth (ROW) - Thermal Transfer - 600 DPI

PM45A12000000600 PM45A, Full Touch Display, Ethernet, Bluetooth V5.0, WiFi Rest of World (ROW) IEEE 802.11 a/b/g/n/ac, Fixed Hanger, Real Time Clock (RTC), Thermal Transfer (TT), 600 DPI, No Power Cord

Included in the box:

- PM45A
- PM45 Regulatory Sheet (PM45-ML-RS-01)
- Collapsible Core



- No Power Cord

Note: Not all printer combinations are available in every region. Check your local Price Book to see which part numbers are available for sale.

Honeywell Repair Services

SVCPM45-SG3N PM45 / PM45C, Edge Service, Gold Maintenance Contract, 3 Year, New Contract

ADD SVCPRINTHEAD-PRN3 AddOn, Edge Service, Printhead Refresh Service, 203 or 300 DPI, 3-Year Contract

ADD SVCACC-PRN3 AddOn, Edge Service, Accessory Service, Printer, 3 Year

PM45 FEATURE OVERVIEW

Tear Off - Full Touch Display - Thermal Transfer - WiFi/ Bluetooth (NA)

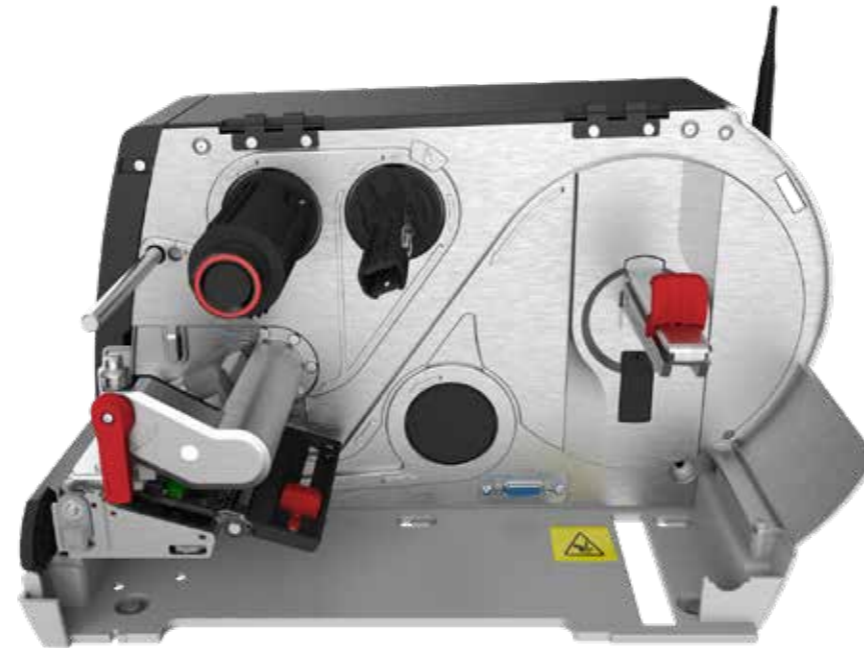
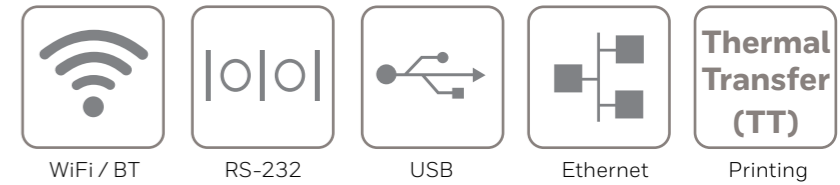

PM45A - Full Touch - WiFi/ Bluetooth (NA) - Thermal Transfer - 203 DPI

PM45A11000000201

PM45A, Full Touch Display, Ethernet, Bluetooth V5.0, WiFi Rest of World (NA) IEEE 802.11 a/b/g/n/ac, Fixed Hanger, Real Time Clock (RTC), Thermal Transfer (TT), 203 DPI, US Power Cord

PM45A - Full Touch - WiFi/ Bluetooth (NA) - Thermal Transfer - 300 DPI

PM45A11000000301

PM45A, Full Touch Display, Ethernet, Bluetooth V5.0, WiFi Rest of World (NA) IEEE 802.11 a/b/g/n/ac, Fixed Hanger, Real Time Clock (RTC), Thermal Transfer (TT), 300 DPI, US Power Cord

Included in the box:

- PM45A
- PM45 Regulatory Sheet (PM45-ML-RS-01)
- Collapsible Core



- US Power Cord

Note: Not all printer combinations are available in every region. Check your local Price Book to see which part numbers are available for sale.

Honeywell Repair Services

SVCPM45-SG3N

PM45 / PM45C, Edge Service, Gold Maintenance Contract, 3 Year, New Contract

ADD SVCPRINTHEAD-PRN3

AddOn, Edge Service, Printhead Refresh Service, 203 or 300 DPI, 3-Year Contract

ADD SVCACC-PRN3

AddOn, Edge Service, Accessory Service, Printer, 3 Year

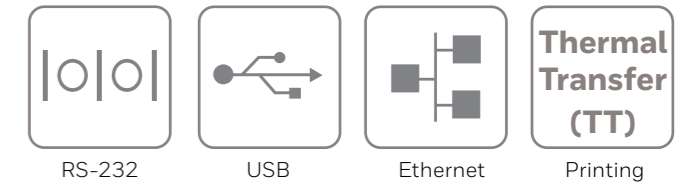

PM45 FEATURE OVERVIEW

Tear Off - Icon Display - Thermal Transfer

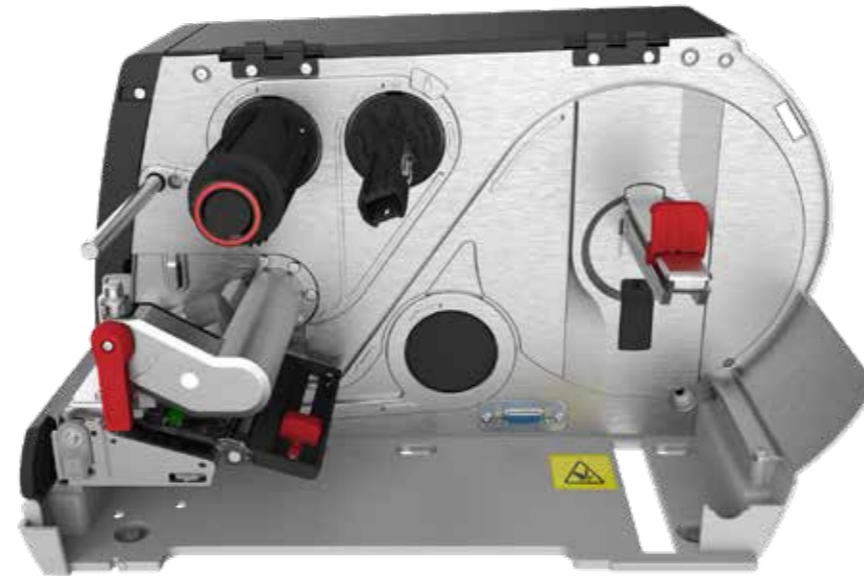

PM45A - Icon - Thermal Transfer - 203 DPI

PM45A00000000200 PM45A, Icon Display, Ethernet, Fixed Hanger, Real Time Clock (RTC), Thermal Transfer (TT), 203 DPI, No Power Cord

PM45A - Icon - Thermal Transfer - 300 DPI

PM45A00000000300 PM45A, Icon Display, Ethernet, Fixed Hanger, Real Time Clock (RTC), Thermal Transfer (TT), 300 DPI, No Power Cord

PM45A - Icon - Thermal Transfer - 406 DPI

PM45A00000000400 PM45A, Icon Display, Ethernet, Fixed Hanger, Real Time Clock (RTC), Thermal Transfer (TT), 406 DPI, No Power Cord

PM45A - Icon - Thermal Transfer - 600 DPI

PM45A00000000600 PM45A, Icon Display, Ethernet, Fixed Hanger, Real Time Clock (RTC), Thermal Transfer (TT), 600 DPI, No Power Cord

Included in the box:

- PM45A
- PM45 Regulatory Sheet (PM45-ML-RS-01)
- Collapsible Core



- No Power Cord

Note: Not all printer combinations are available in every region. Check your local Price Book to see which part numbers are available for sale.

Honeywell Repair Services

SVC PM45-SG3N	PM45 / PM45C, Edge Service, Gold Maintenance Contract, 3 Year, New Contract
ADD SVCPRINTHEAD-PRN3	AddOn, Edge Service, Printhead Refresh Service, 203 or 300 DPI, 3-Year Contract
ADD SVCACC-PRN3	AddOn, Edge Service, Accessory Service, Printer, 3 Year

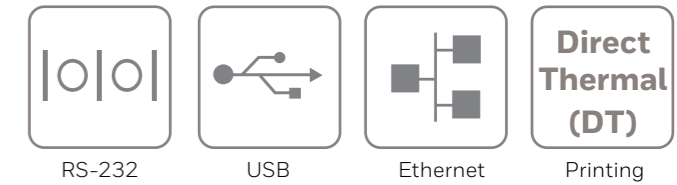

PM45 FEATURE OVERVIEW

Tear Off - Icon Display - Direct Thermal

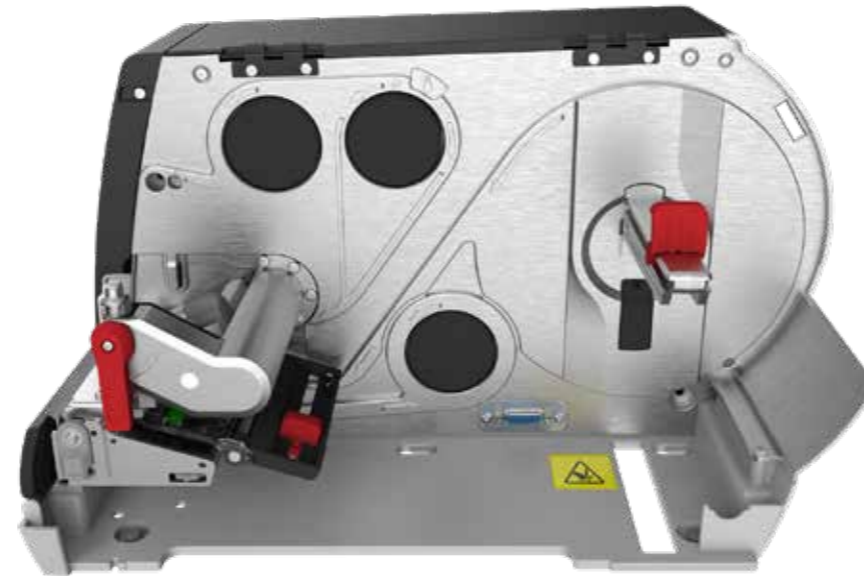

PM45A - Icon - Direct Thermal - 203 DPI

PM45A00000000210 PM45A, Icon Display, Ethernet, Fixed Hanger, Real Time Clock (RTC), Direct Thermal (DT), 203 DPI, No Power Cord

PM45A - Icon - Direct Thermal - 300 DPI

PM45A00000000310 PM45A, Icon Display, Ethernet, Fixed Hanger, Real Time Clock (RTC), Direct Thermal (DT), 300 DPI, No Power Cord

PM45A - Icon - Direct Thermal - 406 DPI

PM45A00000000410 PM45A, Icon Display, Ethernet, Fixed Hanger, Real Time Clock (RTC), Direct Thermal (DT), 406 DPI, No Power Cord

PM45A - Icon - Direct Thermal - 600 DPI

PM45A00000000610 PM45A, Icon Display, Ethernet, Fixed Hanger, Real Time Clock (RTC), Direct Thermal (DT), 600 DPI, No Power Cord

Included in the box:

- PM45A
- PM45 Regulatory Sheet (PM45-ML-RS-01)
- No Power Cord

Note: Not all printer combinations are available in every region. Check your local Price Book to see which part numbers are available for sale.

Honeywell Repair Services

SVCPM45-SG3N PM45 / PM45C, Edge Service, Gold Maintenance Contract, 3 Year, New Contract

ADD SVCPRINTHEAD-PRN3 AddOn, Edge Service, Printhead Refresh Service, 203 or 300 DPI, 3-Year Contract

ADD SVCACC-PRN3 AddOn, Edge Service, Accessory Service, Printer, 3 Year

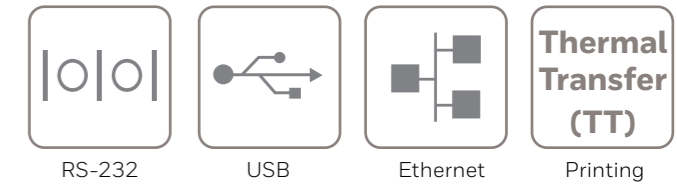

PM45 FEATURE OVERVIEW

Rewinder + Label Taken Sensor – Full Touch Display – Thermal Transfer

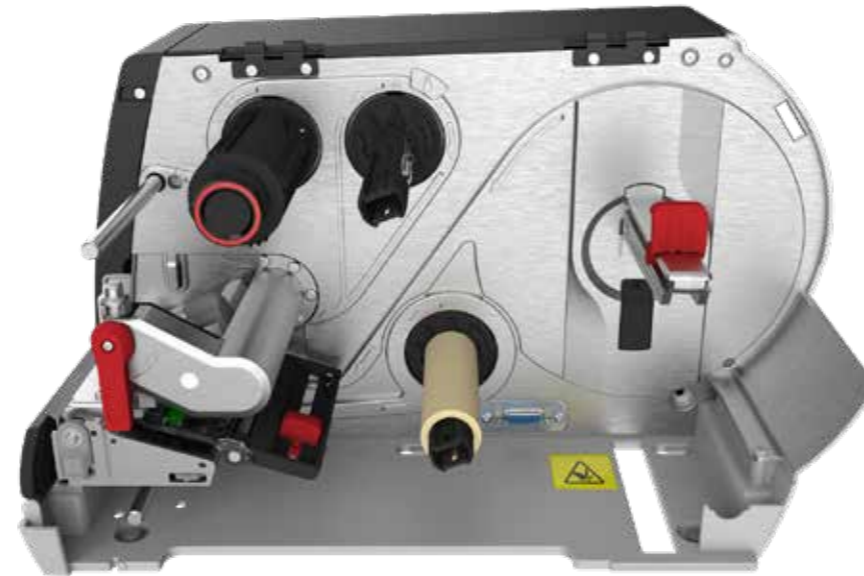

PM45A - Full Touch - Internal Rewind + Label Taken Sensor - Thermal Transfer - 203 DPI

PM45A10000030200 PM45A, Full Touch Display, Ethernet, Fixed Hanger, Rewinder + Label Taken Sensor, Real Time Clock (RTC), Thermal Transfer (TT), 203 DPI, No Power Cord

PM45A - Full Touch - Internal Rewind + Label Taken Sensor - Thermal Transfer - 300 DPI

PM45A10000030300 PM45A, Full Touch Display, Ethernet, Fixed Hanger, Rewinder + Label Taken Sensor, Real Time Clock (RTC), Thermal Transfer (TT), 300 DPI, No Power Cord

PM45A - Full Touch - Internal Rewind + Label Taken Sensor - Thermal Transfer - 406 DPI

PM45A10000030400 PM45A, Full Touch Display, Ethernet, Fixed Hanger, Rewinder + Label Taken Sensor, Real Time Clock (RTC), Thermal Transfer (TT), 406 DPI, No Power Cord

PM45A - Full Touch - Internal Rewind + Label Taken Sensor - Thermal Transfer - 600 DPI

PM45A10000030600 PM45A, Full Touch Display, Ethernet, Fixed Hanger, Rewinder + Label Taken Sensor, Real Time Clock (RTC), Thermal Transfer (TT), 600 DPI, No Power Cord

Included in the box:

- PM45A
- PM45 Regulatory Sheet (PM45-ML-RS-01)
- Collapsible Core

- Batch Plate (653-679-001) - Not installed in PM45

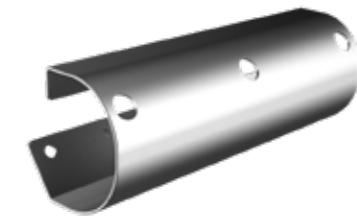

- No Power Cord

- Ribbon Core (048524)



Note: Not all printer combinations are available in every region. Check your local Price Book to see which part numbers are available for sale.

Honeywell Repair Services

SVCPM45-SG3N

PM45 / PM45C, Edge Service, Gold Maintenance Contract, 3 Year, New Contract

ADD SVCPRINHEAD-PRN3

AddOn, Edge Service, Printhead Refresh Service, 203 or 300 DPI, 3-Year Contract

ADD SVCACC-PRN3

AddOn, Edge Service, Accessory Service, Printer, 3 Year

PM45 FEATURE OVERVIEW

Rewinder + Label Taken Sensor - Full Touch Display - Parallel Interface - Thermal Transfer

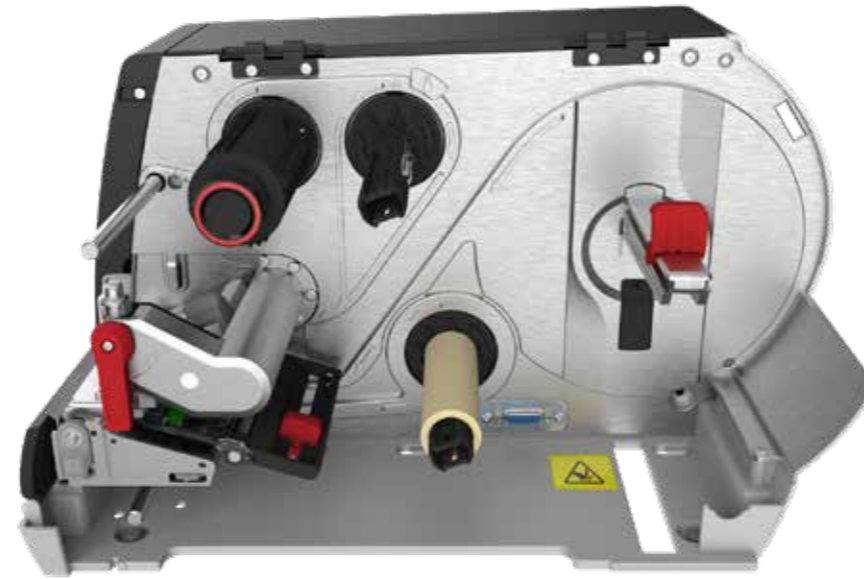
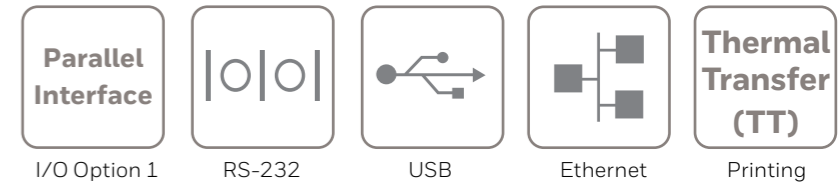

PM45A - Full Touch - Internal Rewind + Label Taken Sensor - Parallel Interface - Thermal Transfer - 203 DPI

PM45A10010030200 PM45A, Full Touch Display, Ethernet, Fixed Hanger, Parallel Interface, Rewinder + Label Taken Sensor, Real Time Clock (RTC), Thermal Transfer (TT), 203 DPI, No Power Cord

PM45A - Full Touch - Internal Rewind + Label Taken Sensor - Parallel Interface - Thermal Transfer - 300 DPI

PM45A10010030300 PM45A, Full Touch Display, Ethernet, Fixed Hanger, Parallel Interface, Rewinder + Label Taken Sensor, Real Time Clock (RTC), Thermal Transfer (TT), 300 DPI, No Power Cord

PM45A - Full Touch - Internal Rewind + Label Taken Sensor - Parallel Interface - Thermal Transfer - 406 DPI

PM45A10010030400 PM45A, Full Touch Display, Ethernet, Fixed Hanger, Parallel Interface, Rewinder + Label Taken Sensor, Real Time Clock (RTC), Thermal Transfer (TT), 406 DPI, No Power Cord

PM45A - Full Touch - Internal Rewind + Label Taken Sensor - Parallel Interface - Thermal Transfer - 600 DPI

PM45A10010030600 PM45A, Full Touch Display, Ethernet, Fixed Hanger, Parallel Interface, Rewinder + Label Taken Sensor, Real Time Clock (RTC), Thermal Transfer (TT), 600 DPI, No Power Cord

Included in the box:

- PM45A
- PM45 Regulatory Sheet (PM45-ML-RS-01)
- Collapsible Core

- Batch Plate (653-679-001) - Not installed in PM45

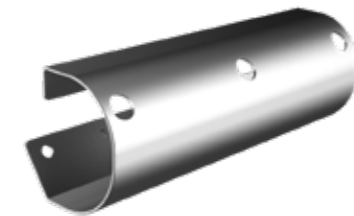

- No Power Cord

- Ribbon Core (048524)



Note: Not all printer combinations are available in every region. Check your local Price Book to see which part numbers are available for sale.

Honeywell Repair Services

SVC SPCPM45-SG3N	PM45 / PM45C, Edge Service, Gold Maintenance Contract, 3 Year, New Contract
ADD SVCPRINTHEAD-PRN3	AddOn, Edge Service, Printhead Refresh Service, 203 or 300 DPI, 3-Year Contract
ADD SVCACC-PRN3	AddOn, Edge Service, Accessory Service, Printer, 3 Year

PM45 FEATURE OVERVIEW

Rewinder + Label Taken Sensor - Full Touch Display - Industrial Interface - Thermal Transfer

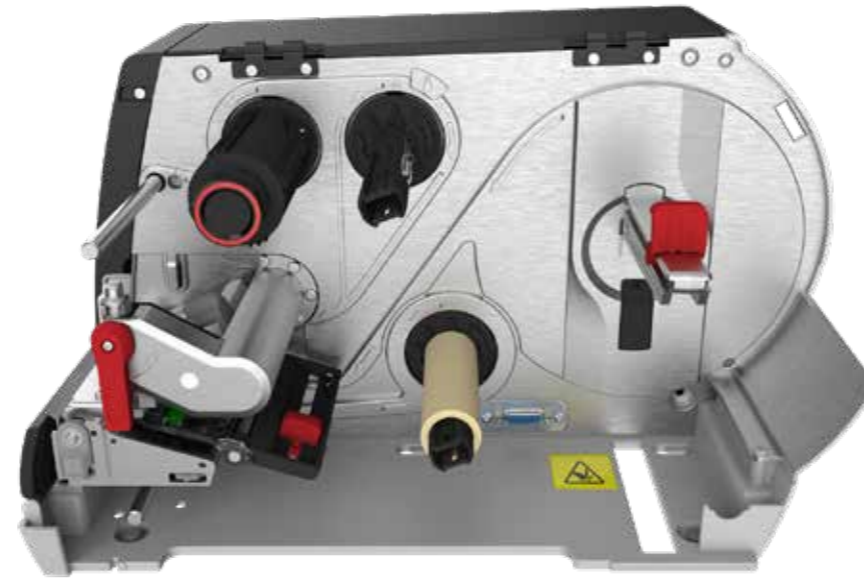
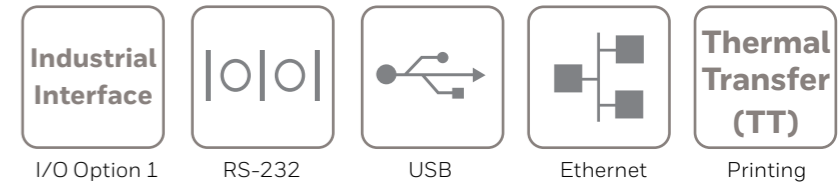

PM45A - Full Touch - Internal Rewind + Label Taken Sensor - Industrial Interface - Thermal Transfer - 203 DPI

PM45A10020030200 PM45A, Full Touch Display, Ethernet, Fixed Hanger, Industrial Interface, Rewinder + Label Taken Sensor, Real Time Clock (RTC), Thermal Transfer (TT), 203 DPI, No Power Cord

PM45A - Full Touch - Internal Rewind + Label Taken Sensor - Industrial Interface - Thermal Transfer - 300 DPI

PM45A10020030300 PM45A, Full Touch Display, Ethernet, Fixed Hanger, Industrial Interface, Rewinder + Label Taken Sensor, Real Time Clock (RTC), Thermal Transfer (TT), 300 DPI, No Power Cord

PM45A - Full Touch - Internal Rewind + Label Taken Sensor - Industrial Interface - Thermal Transfer - 406 DPI

PM45A10020030400 PM45A, Full Touch Display, Ethernet, Fixed Hanger, Industrial Interface, Rewinder + Label Taken Sensor, Real Time Clock (RTC), Thermal Transfer (TT), 406 DPI, No Power Cord

PM45A - Full Touch - Internal Rewind + Label Taken Sensor - Industrial Interface - Thermal Transfer - 600 DPI

PM45A10020030600 PM45A, Full Touch Display, Ethernet, Fixed Hanger, Industrial Interface, Rewinder + Label Taken Sensor, Real Time Clock (RTC), Thermal Transfer (TT), 600 DPI, No Power Cord

Included in the box:

- PM45A
- PM45 Regulatory Sheet (PM45-ML-RS-01)
- Collapsible Core

- Batch Plate (653-679-001) - Not installed in PM45



- No Power Cord

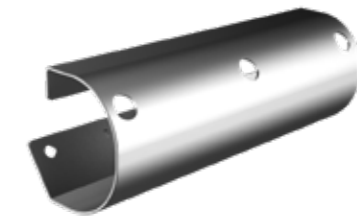

- Ribbon Core (048524)



Note: Not all printer combinations are available in every region. Check your local Price Book to see which part numbers are available for sale.

Honeywell Repair Services

SVC PM45-SG3N	PM45 / PM45C, Edge Service, Gold Maintenance Contract, 3 Year, New Contract
ADD SVCPRINTHEAD-PRN3	AddOn, Edge Service, Printhead Refresh Service, 203 or 300 DPI, 3-Year Contract
ADD SVCACC-PRN3	AddOn, Edge Service, Accessory Service, Printer, 3 Year

PM45 FEATURE OVERVIEW

Rewinder + Label Taken Sensor - Full Touch Display - Applicator Interface - Thermal Transfer

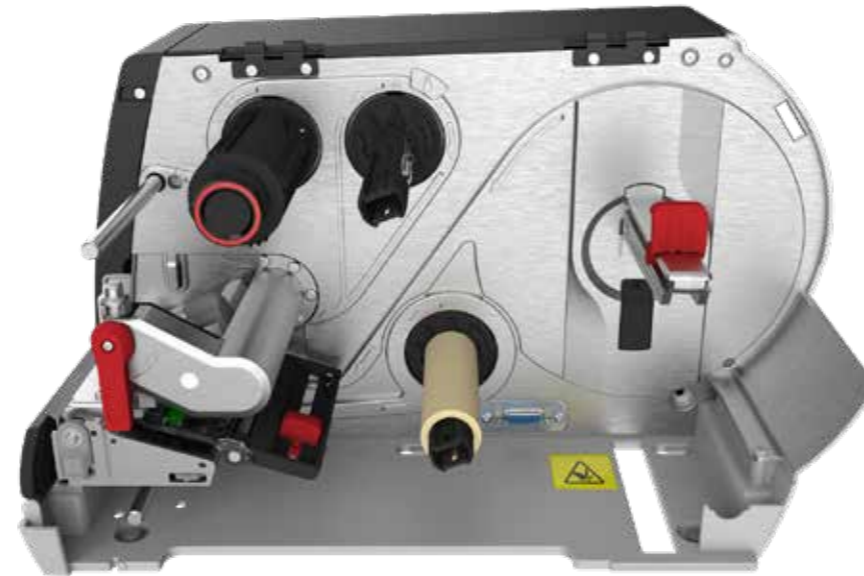
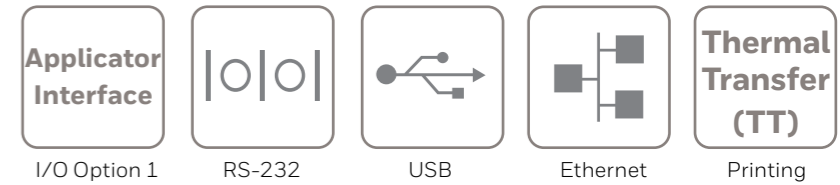

PM45A - Full Touch - Internal Rewind + Label Taken Sensor - Applicator Interface - Thermal Transfer - 203 DPI

PM45A10030030200 PM45A, Full Touch Display, Ethernet, Fixed Hanger, Applicator Interface, Rewinder + Label Taken Sensor, Real Time Clock (RTC), Thermal Transfer (TT), 203 DPI, No Power Cord

PM45A - Full Touch - Internal Rewind + Label Taken Sensor - Applicator Interface - Thermal Transfer - 300 DPI

PM45A10030030300 PM45A, Full Touch Display, Ethernet, Fixed Hanger, Applicator Interface, Rewinder + Label Taken Sensor, Real Time Clock (RTC), Thermal Transfer (TT), 300 DPI, No Power Cord

PM45A - Full Touch - Internal Rewind + Label Taken Sensor - Applicator Interface - Thermal Transfer - 406 DPI

PM45A10030030400 PM45A, Full Touch Display, Ethernet, Fixed Hanger, Applicator Interface, Rewinder + Label Taken Sensor, Real Time Clock (RTC), Thermal Transfer (TT), 406 DPI, No Power Cord

PM45A - Full Touch - Internal Rewind + Label Taken Sensor - Applicator Interface - Thermal Transfer - 600 DPI

PM45A10030030600 PM45A, Full Touch Display, Ethernet, Fixed Hanger, Applicator Interface, Rewinder + Label Taken Sensor, Real Time Clock (RTC), Thermal Transfer (TT), 600 DPI, No Power Cord

Included in the box:

- PM45A
- PM45 Regulatory Sheet (PM45-ML-RS-01)
- Collapsible Core

- Batch Plate (653-679-001) - Not installed in PM45

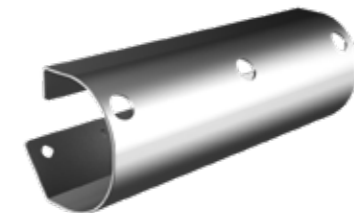

- No Power Cord

- Ribbon Core (048524)



Note: Not all printer combinations are available in every region. Check your local Price Book to see which part numbers are available for sale.

Honeywell Repair Services

SVC PM45-SG3N	PM45 / PM45C, Edge Service, Gold Maintenance Contract, 3 Year, New Contract
ADD SVCPRINTHEAD-PRN3	AddOn, Edge Service, Printhead Refresh Service, 203 or 300 DPI, 3-Year Contract
ADD SVCACC-PRN3	AddOn, Edge Service, Accessory Service, Printer, 3 Year

PM45 FEATURE OVERVIEW

Rewinder + Label Taken Sensor - Full Touch Display - Thermal Transfer - RFID (EU)

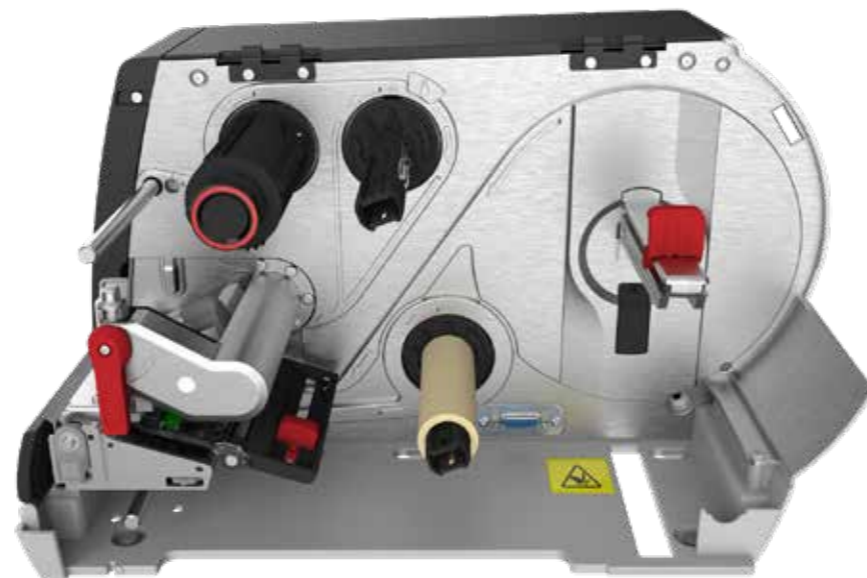
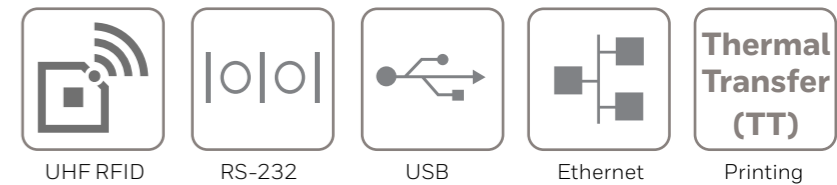

PM45A - Full Touch - Internal Rewind + Label Taken Sensor - UHF RFID - Thermal Transfer - 203 DPI

PM45A1000EU30200

PM45A, Full Touch Display, Ethernet, UHF RFID Europe/ ROW (EU) Fixed Hanger, Rewinder + Label Taken Sensor, Real Time Clock (RTC), Thermal Transfer (TT), 203 DPI, No Power Cord

Included in the box:

- PM45A
- PM45 Regulatory Sheet (PM45-ML-RS-01)
- Collapsible Core

- Batch Plate (653-679-001) - Not installed in PM45



- No Power Cord

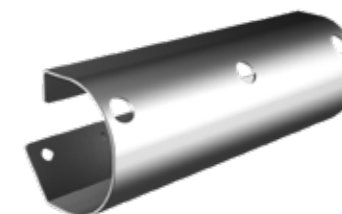

- Ribbon Core (048524)



Note: Not all printer combinations are available in every region. Check your local Price Book to see which part numbers are available for sale.

Honeywell Repair Services

SVCPM45-SG3N

PM45 / PM45C, Edge Service, Gold Maintenance Contract, 3 Year, New Contract

ADD SVCPRINTHEAD-PRN3

AddOn, Edge Service, Printhead Refresh Service, 203 or 300 DPI, 3-Year Contract

ADD SVCACC-PRN3

AddOn, Edge Service, Accessory Service, Printer, 3 Year

PM45 FEATURE OVERVIEW

Rewinder + Label Taken Sensor - Full Touch Display - Thermal Transfer

WiFi/ Bluetooth (NA) - WWAN - RFID (NA)

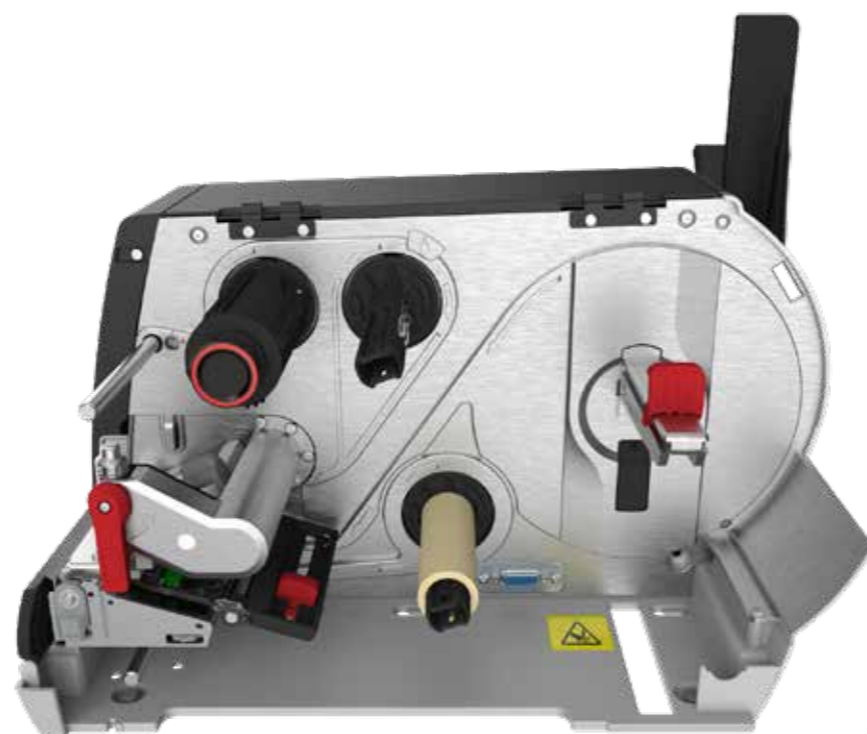

PM45A - Full Touch - Internal Rewind + Label Taken Sensor - WiFi/ Bluetooth - WWAN - UHF RFID - TT - 203 DPI

PM45A11NA0430201 PM45A, Full Touch Display, Ethernet, Bluetooth V5.0, WiFi North America (NA) IEEE 802.11 a/b/g/n/ac, UHF RFID North America (NA), WWAN 4G LTE North America (NA), Fixed Hanger, Rewinder + Label Taken Sensor, Real Time Clock (RTC), Thermal Transfer (TT), 203 DPI, US Power Cord

PM45A - Full Touch - Internal Rewind + Label Taken Sensor - WiFi/ Bluetooth - WWAN - UHF RFID - TT - 300 DPI

PM45A11NA0430301 PM45A, Full Touch Display, Ethernet, Bluetooth V5.0, WiFi North America (NA) IEEE 802.11 a/b/g/n/ac, UHF RFID North America (NA), WWAN 4G LTE North America (NA), Fixed Hanger, Rewinder + Label Taken Sensor, Real Time Clock (RTC), Thermal Transfer (TT), 300 DPI, US Power Cord

Included in the box:

- PM45A
- PM45 Regulatory Sheet (PM45-ML-RS-01)
- Collapsible Core

- Batch Plate (653-679-001) - Not installed in PM45



- US Power Cord

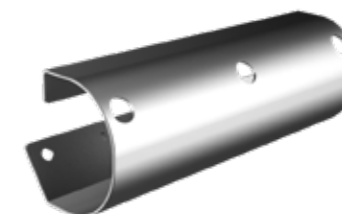

- Ribbon Core (048524)



Honeywell Repair Services

SVCPM45-SG3N PM45 / PM45C, Edge Service, Gold Maintenance Contract, 3 Year, New Contract





ADD SVCPRINTHEAD-PRN3 AddOn, Edge Service, Printhead Refresh Service, 203 or 300 DPI, 3-Year Contract

ADD SVCACC-PRN3 AddOn, Edge Service, Accessory Service, Printer, 3 Year

Note: Not all printer combinations are available in every region. Check your local Price Book to see which part numbers are available for sale.

PM45G FEATURE OVERVIEW

Rewinder + Label Taken Sensor - Full Touch Display - Parallel Interface - Thermal Transfer

 Parallel Interface I/O Option 1	 RS-232	 USB	 Ethernet	 Thermal Transfer (TT) Printing
---	---	--	---	---

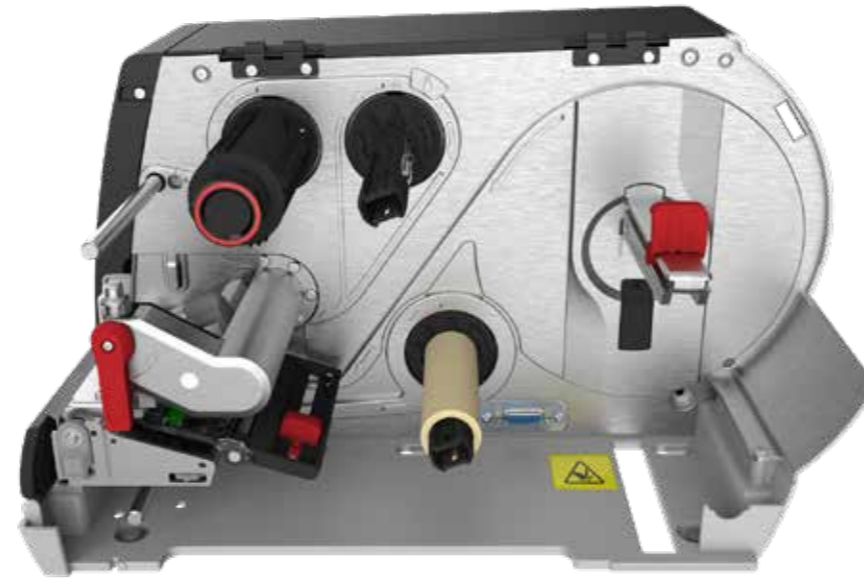

PM45G - Full Touch - Internal Rewind + Label Taken Sensor - Parallel Interface - Thermal Transfer - 203 DPI

PM45G10010030201

PM45G, Full Touch Display, Ethernet, Fixed Hanger, Parallel Interface, Rewinder + Label Taken Sensor, Real Time Clock (RTC), Thermal Transfer (TT), 203 DPI, US Power Cord

Included in the box:

- PM45G
- PM45 Regulatory Sheet (PM45-ML-RS-01)
- Collapsible Core

- Batch Plate (653-679-001) - Not installed in PM45



- US Power Cord

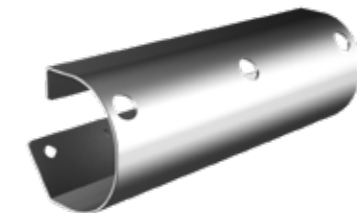

- Ribbon Core (048524)



Note: Not all printer combinations are available in every region. Check your local Price Book to see which part numbers are available for sale.

Honeywell Repair Services

SVCPM45-SG3N	PM45 / PM45C, Edge Service, Gold Maintenance Contract, 3 Year, New Contract
ADD SVCPRINTHEAD-PRN3	AddOn, Edge Service, Printhead Refresh Service, 203 or 300 DPI, 3-Year Contract
ADD SVCACC-PRN3	AddOn, Edge Service, Accessory Service, Printer, 3 Year

PM45G FEATURE OVERVIEW

Full Batch Rewinder + Label Taken Sensor - Full Touch Display

Parallel Interface - Thermal Transfer

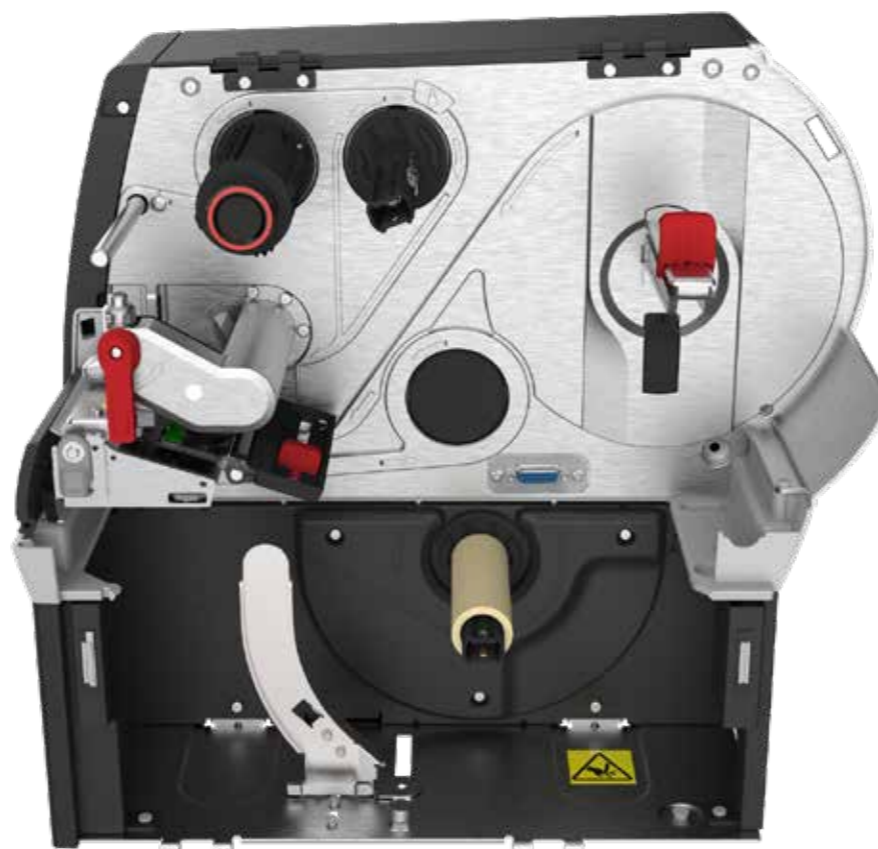
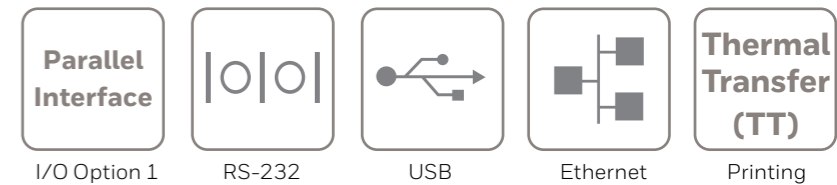

PM45G - Full Touch - Full Batch Rewinder + Label Taken Sensor - Parallel Interface - TT - 203 DPI

PM45G10010050201

PM45G, Full Touch Display, Ethernet, Fixed Hanger, Parallel Interface, Full Batch Rewinder + Label Taken Sensor, Real Time Clock (RTC), Thermal Transfer (TT), 203 DPI, US Power Cord

Included in the box:

- PM45G
- PM45 Regulatory Sheet (PM45-ML-RS-01)
- Collapsible Core

- Batch Plate (653-679-001) - Not installed in PM45



- US Power Cord

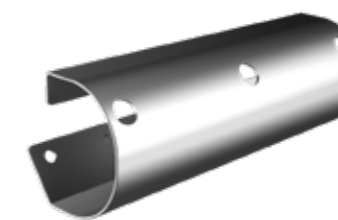

- Ribbon Core (O48524)



Note: Not all printer combinations are available in every region. Check your local Price Book to see which part numbers are available for sale.

Honeywell Repair Services

SVCPM45-SG3N

PM45 / PM45C, Edge Service, Gold Maintenance Contract, 3 Year, New Contract

ADD SVCPRINTHEAD-PRN3

AddOn, Edge Service, Printhead Refresh Service, 203 or 300 DPI, 3-Year Contract

ADD SVCACC-PRN3

AddOn, Edge Service, Accessory Service, Printer, 3 Year

PM45 CONFIGURATION MAP

Industrial Printer

VERSION
USER INTERFACE
CONNECTIVITY
I/O OPTION 1
I/O OPTION 2
OPTION 1
MEDIA HANDLING
PRINT OPTION
POWER CORD

PM45								DESCRIPTION	NOTES
A								Standard	2 x USB A Port (USB 2.0 Host), 1 x USB B Port (USB 2.0 Device), 1 x DB9F (RS-232, up to 115.2 KB/s), Real Time Clock (RTC)
G								Trade Agreements Act (TAA) Compliant	2 x USB A Port (USB 2.0 Host), 1 x USB B Port (USB 2.0 Device), 1 x DB9F (RS-232, up to 115.2 KB/s), Real Time Clock (RTC)
	0							Icon User Interface	
	1							Full Touch User Interface	
	2							Icon User Interface + Bluetooth Low Energy (BLE)	Bluetooth Low Energy (BLE) used for communication with Printset MC Application
	3							Full Touch User Interface + Bluetooth Low Energy (BLE)	Bluetooth Low Energy (BLE) used for communication with Printset MC Application
		0						Ethernet	Ethernet 10/100/1000 Mbps
		1						Ethernet + WLAN North America (NA) + Bluetooth	Available as Kit - Part# 50178327-001 WiFi 802.11 a/b/g/n/ac + V5.0 Bluetooth Kit (North America)
		2						Ethernet + WLAN Rest Of World (ROW) + Bluetooth	Available as Kit - Part# 50174832-001 WiFi 802.11 a/b/g/n/ac + V5.0 Bluetooth Kit (Rest Of World)
			00					None	
			01					Parallel Interface	Available as Kit - Part# PM45-PAR-01 PARALLEL IEEE 1284 INTERFACE PM45
			02					Industrial Interface	Available as Kit - Part# PM45-IND-01 UART + INDUSTRIAL INTERFACE PM45
			03					Applicator Interface	Available as Kit - Part# PM45-APPL-01 APPLICATOR INTERFACE PM45
			EU					UHF RFID Europe (EU) - 869MHz	Available as Kit - Part# 50180233-001 RFID IM11 INTERFACE EU/ ROW,ASSY,PM45
			NA					UHF RFID North America (NA) - 915MHz	Available as Kit - Part# 50180747-001 RFID IM11 INTERFACE NA,ASSY,PM45
			00					None	
			01					Parallel Interface	Available as Kit - Part# PM45-PAR-01 PARALLEL IEEE 1284 INTERFACE PM45
			02					Industrial Interface	Available as Kit - Part# PM45-IND-01 UART + INDUSTRIAL INTERFACE PM45
			03					Applicator Interface	Available as Kit - Part# PM45-APPL-01 APPLICATOR INTERFACE PM45
			04					WWAN 4G LTE	Available as Kit - Part# 50179990-001 Cellular Modem,Assy,PM45
			EU					UHF RFID Europe (EU) - 869MHz	Available as Kit - Part# 50180233-001 RFID IM11 INTERFACE EU/ ROW,ASSY,PM45
			NA					UHF RFID North America (NA) - 915MHz	Available as Kit - Part# 50180747-001 RFID IM11 INTERFACE NA,ASSY,PM45
			0					None	
			1					Label Taken Sensor (LTS)	Available as Kit - Part# 715-616S-001 Label Taken Sensor (LTS), Spare Kit, PM43/ PM45
			2					Rewinder	Available as Kit - Part# 50178326-001 PM45 Rewinder,Media Internal Sub-Assembly
			3					Rewinder + Label Taken Sensor (LTS)	Available as Kit - Part# 50178326-001 PM45 Rewinder,Media Internal Sub-Assembly + Part# 715-616S-001 Label Taken Sensor (LTS), PM45
			4					Full Batch Rewinder	Available as Kit - Part# 50178308-001 KIT, PM45 Full Batch Rewinder (Field option kit)
			5					Full Batch Rewinder + Label Taken Sensor (LTS)	Available as Kit - Part# 50178308-001 KIT, PM45 Full Batch Rewinder (Field option kit) + Part# 715-616S-001 Label Taken Sensor (LTS), PM45
			0					Fixed Hanger	
			1					Rotating Hanger	Available as Kit - Part# 203-977-001 KIT, ROTATION HANGER + Part# 203-972-001 - 3 inch Media Core
			20					Thermal Transfer (TT) 203 DPI	Available as Kit - Part# 50180236-001 PRINthead ASSY 203 DPI,PM45/PM45C
			21					Direct Thermal (DT) 203 DPI	Available as Kit - Part# 50180236-001 PRINthead ASSY 203 DPI,PM45/PM45C
			30					Thermal Transfer (TT) 300 DPI	Available as Kit - Part# 50180237-001 PRINthead ASSY 300 DPI,PM45/PM45C
			31					Direct Thermal (DT) 300 DPI	Available as Kit - Part# 50180237-001 PRINthead ASSY 300 DPI,PM45/PM45C
			40					Thermal Transfer (TT) 406 DPI	Available as Kit - Part# 50180238-001 PRINthead ASSY 406 DPI,PM45/PM45C
			41					Direct Thermal (DT) 406 DPI	Available as Kit - Part# 50180238-001 PRINthead ASSY 406 DPI,PM45/PM45C
			60					Thermal Transfer (TT) 600 DPI	Available as Kit - Part# 50180234-001 PRINthead ASSY 600 DPI,PM45/PM45C
			61					Direct Thermal (DT) 600 DPI	Available as Kit - Part# 50180234-001 PRINthead ASSY 600 DPI,PM45/PM45C
			0					None	AC Power Cord C13 Type Connector
			1					US Power Cord	AC Power Cord C13 Type Connector
			2					EU Power Cord	AC Power Cord C13 Type Connector
			6					India Power Cord	AC Power Cord C13 Type Connector



PM45C PRINTING OPTIONS



Tear Off

Most commonly used, print any number of labels and simply tear the labels off from the printer at the end of the print job. This method of printing is available on any PM45C configuration.



Cutter

A cutter can be added to any configuration of PM45C, simply cutting between labels, or at intervals on continuous media. This method of printing is available on any PM45C configuration.

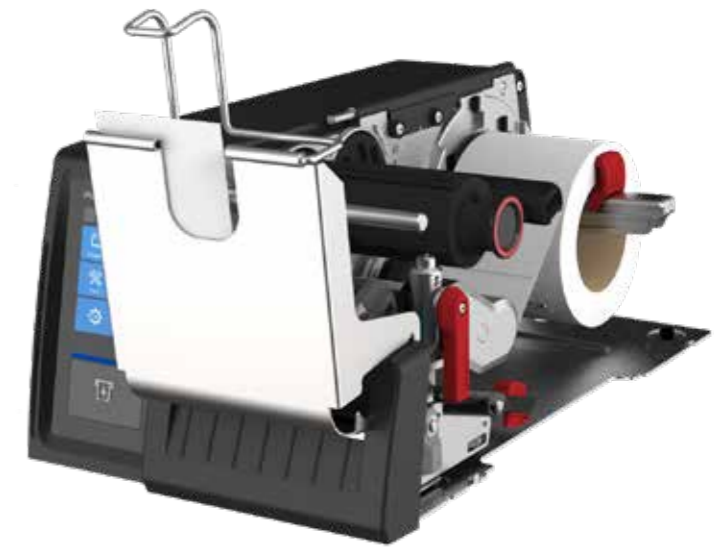

Cutter with Vertical Tray

A vertical tray can be added to the Cutter to present the label upwards within easy reach of the operator, typically used for boarding pass printing in the airline industry.



Peel & Present (Standard Self-Strip using Tear Bar)

Self-Strip prints and presents only one label at a time already peeled from the backing strip/liner, the next label will only be printed once the original label is removed from the media path. Not applicable for all media types, use Peel Off Kit for best results. PM45CAxxxxx3xxxx PM45C with Internal Rewind + LTS



Peel & Present (Enhanced Self-Strip with Peel Off Kit)

Self-Strip prints and presents only one label at a time already peeled from the backing strip/liner, the next label will only be printed once the original label is removed from the media path. PM45CAxxxxx3xxxx PM45C with Internal Rewind + LTS
50180196-001 Label Dispenser kit.



Batch Plate with Internal Rewinder

The Batch Plate with Internal Rewinder is used to pre-print labels and rewind them inside the PM45. Depending on the label size up to 1/3 of a full roll can be stored inside the PM45C. For full roll to roll batch printing use the PM45 with Full Batch Rewinder. PM45CAxxxxx3xxxx PM45C with Internal Rewind + LTS

ID = Inside Diameter
OD = Outside Diameter

PM45C MEDIA

Specifications

Ribbon Capacity
Up to 300 m (11,811 in)
Supports Ink Side In or Ink Side Out

Ribbon Core ID
25 mm (1.0 in)

Label Roll Minimum Width
19 mm (0.75 in)

Label Roll Maximum Width
114 mm (4.5 in)

Label Roll Maximum OD

Short Door	213 mm (8.38 in)
Long Door	152 mm (6.0 in)
Mega Dome Door	213 mm (8.38 in)

Label Roll Core ID
38 mm (1.5 in)
76 mm (3.0 in)

Internal Rewinder Core ID
25 mm (1.0 in)

Optional Collapsible Core - Coreless Media Rewinder
50180221-001
Not included with the printer, must be ordered separately.

Large Collapsible Core

Minimum Label Length

Tear Off	6.35 mm (0.25 in)
Peel-Off Kit	25 mm (1.0 in)
Cutter	25 mm (1.0 in)
Rewind	6.35 mm (0.25 in)
RFID	25 mm (1.0 in)

Maximum Print Width

203 dpi	108 mm (4.25 in)
300 dpi	105.7 mm (4.17 in)
406 dpi	104 mm (4.09 in)
600 dpi	105.6 mm (4.16 in)

PM45C MEDIA

Ribbon Rewinder Capacity

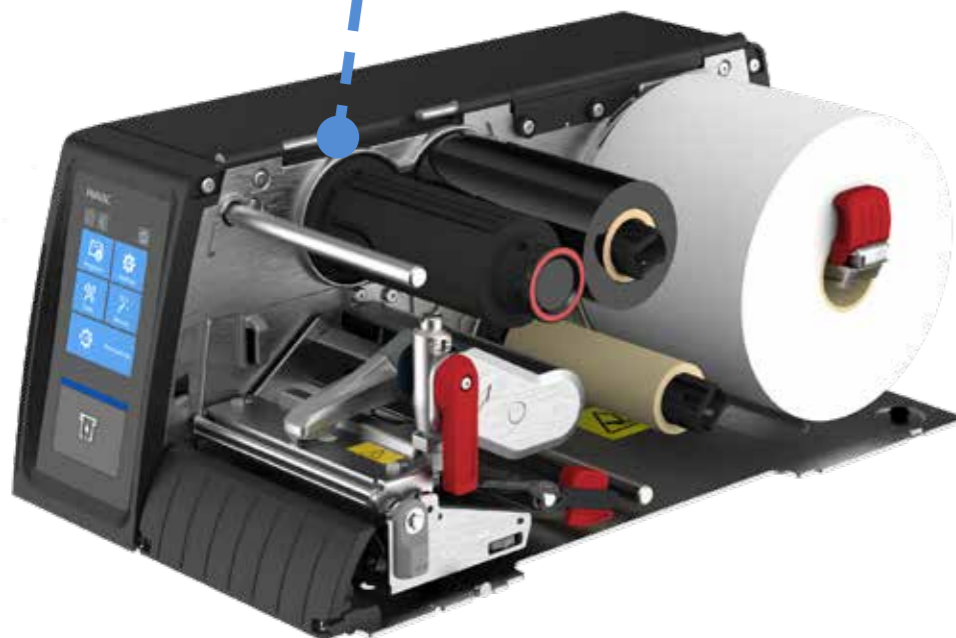

Ribbon Rewind - Large Collapsible Core

Print Precision - Best

Ribbon Removal - Best

50% Ribbon take up capacity from 220m ribbon.

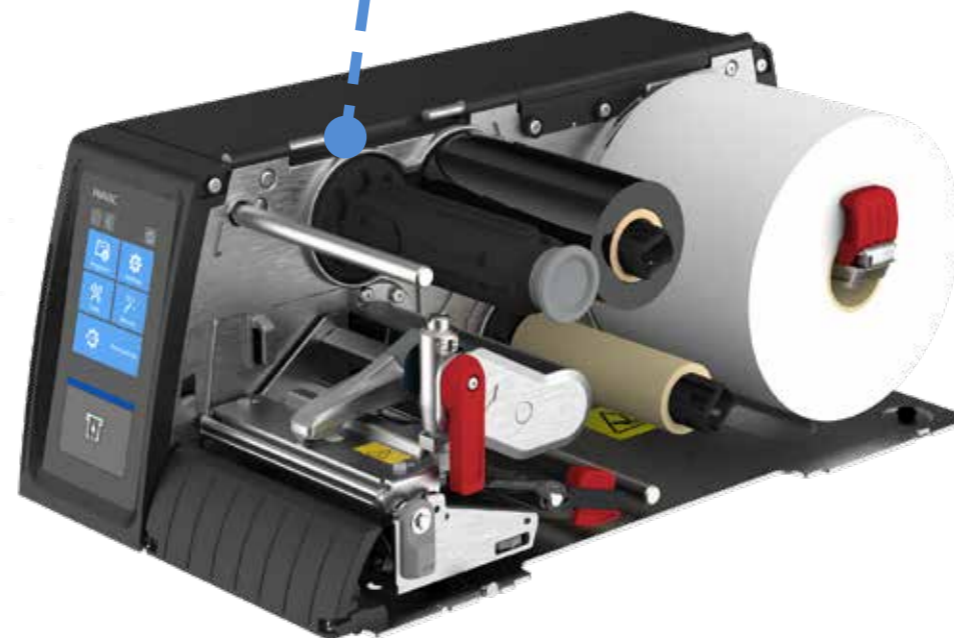

Ribbon Rewind - Small Collapsible Core

Print Precision - Better

Ribbon Removal - Better

80% Ribbon take up capacity from 220m ribbon.

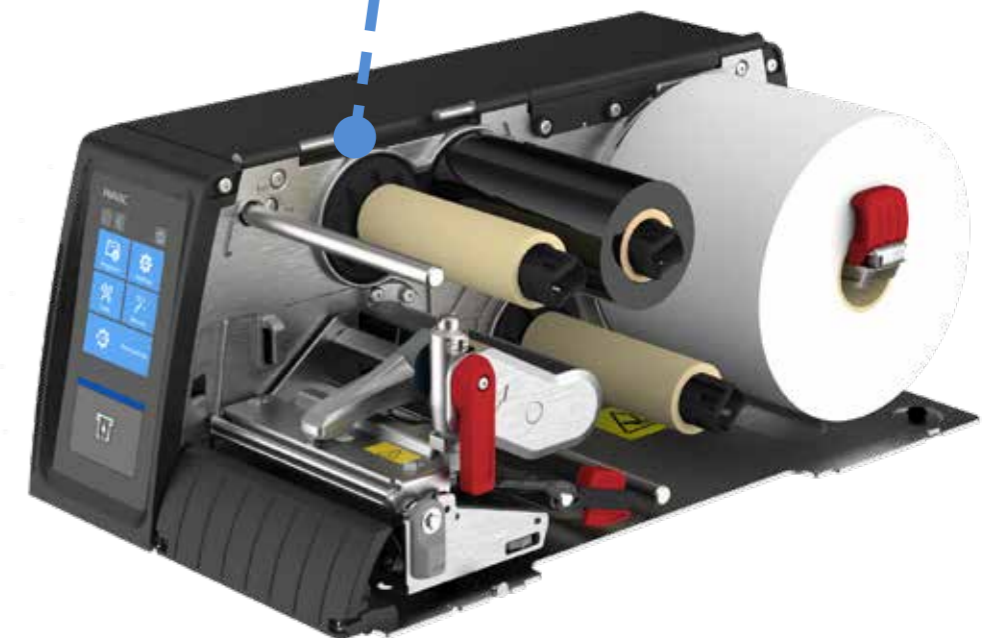

Ribbon Rewind - Empty Core

Print Precision - Good

Ribbon Removal - Good

100% Ribbon take up capacity from 220m ribbon.

ID = Inside Diameter
OD = Outside Diameter

PM45C MEDIA

Short Door, Long Door and Mega Dome Door Label Capacity

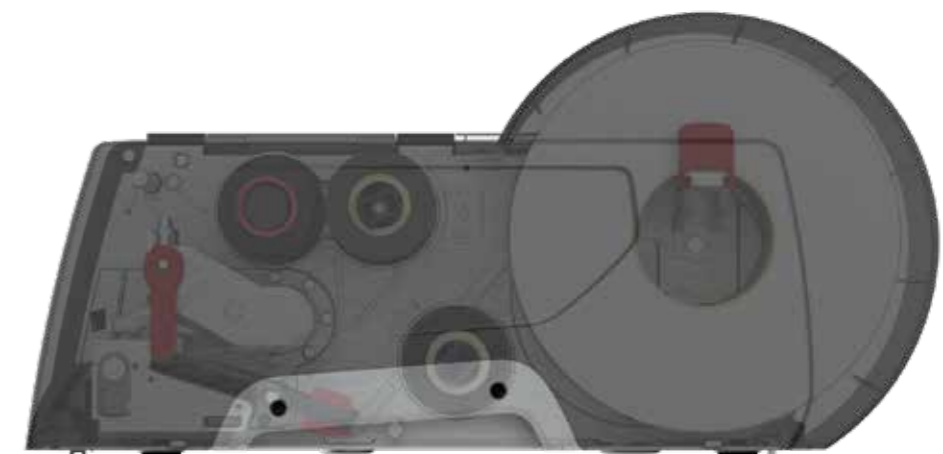
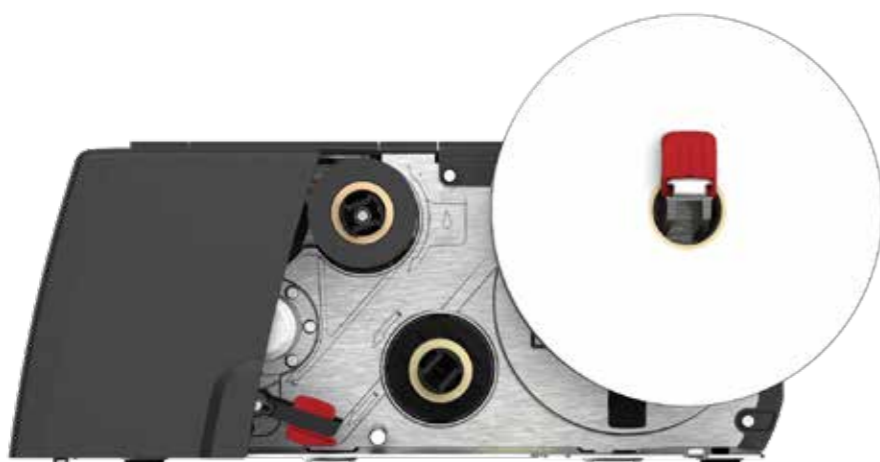
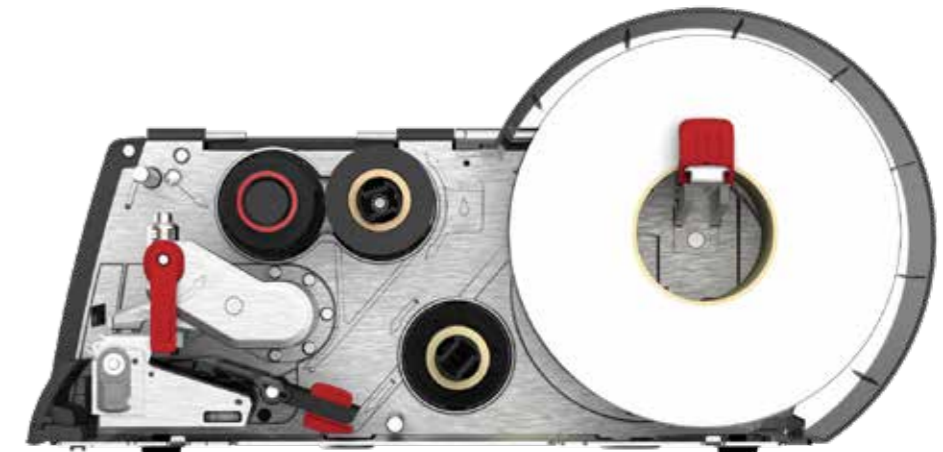
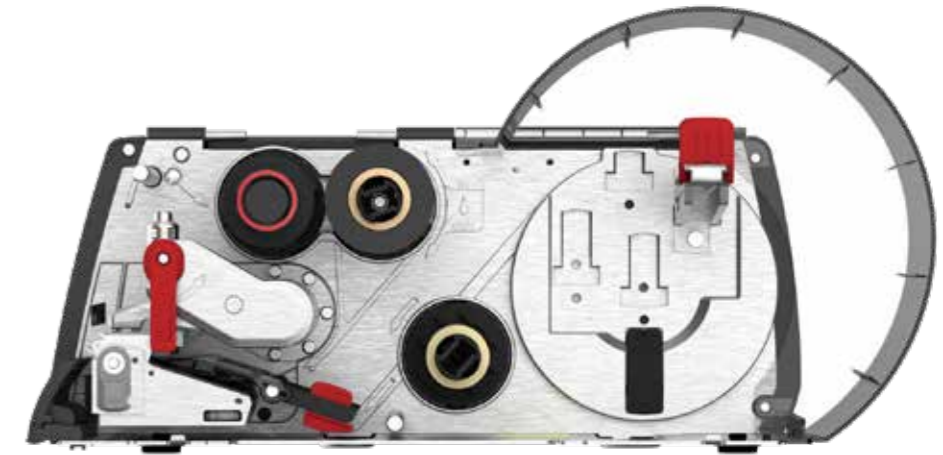

Short Door

Fixed Media Hanger + Label Roll Core 38 mm (1.5 in) ID

Shown with Label Roll: 213 mm (8.38 in) OD

Label Roll Maximum: 213 mm (8.38 in) OD

Typical length of material with typical thickness of labels ~ 220 m

Long Door

Fixed Media Hanger + Label Roll Core 38 mm (1.5 in) ID

Shown with Label Roll: 152 mm (6.0 in) OD

Label Roll Maximum: 152 mm (6.0 in) OD

Typical length of material with typical thickness of labels ~ 108 m

Mega Dome Door

Fixed Media Hanger + Label Roll Core 76 mm (3.0 in) ID

Shown with Label Roll: 213 mm (8.38 in) OD

Label Roll Maximum: 213 mm (8.38 in) OD

Typical length of material with typical thickness of labels ~ 195 m

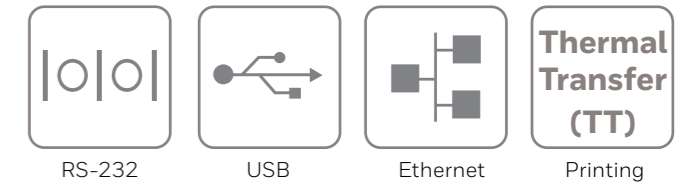

PM45C SHORT DOOR FEATURE OVERVIEW

Tear Off - Full Touch Display - Thermal Transfer



PM45C - Full Touch - Short Door - Thermal Transfer - 203 DPI

PM45CA1010000200 PM45 Compact, Full Touch Display, Ethernet, Short Door, Fixed Hanger, Real Time Clock (RTC), Thermal Transfer (TT), 203 DPI, No Power Cord

PM45C - Full Touch - Short Door -Thermal Transfer - 300 DPI

PM45CA1010000300 PM45 Compact, Full Touch Display, Ethernet, Short Door, Fixed Hanger, Real Time Clock (RTC), Thermal Transfer (TT), 300 DPI, No Power Cord

PM45C - Full Touch - Short Door -Thermal Transfer - 406 DPI

PM45CA1010000400 PM45 Compact, Full Touch Display, Ethernet, Short Door, Fixed Hanger, Real Time Clock (RTC), Thermal Transfer (TT), 406 DPI, No Power Cord

PM45C - Full Touch - Short Door -Thermal Transfer - 600 DPI

PM45CA1010000600 PM45 Compact, Full Touch Display, Ethernet, Short Door, Fixed Hanger, Real Time Clock (RTC), Thermal Transfer (TT), 600 DPI, No Power Cord

Included in the box:

- PM45C
- PM45C Regulatory Sheet (PM45-ML-RS-01)
- Collapsible Core



- No Power Cord

Note: Not all printer combinations are available in every region. Check your local Price Book to see which part numbers are available for sale.

Honeywell Repair Services

SVC PM45-SG3N	PM45 / PM45C, Edge Service, Gold Maintenance Contract, 3 Year, New Contract
ADD SVCPRINTHEAD-PRN3	AddOn, Edge Service, Printhead Refresh Service, 203 or 300 DPI, 3-Year Contract
ADD SVCACC-PRN3	AddOn, Edge Service, Accessory Service, Printer, 3 Year

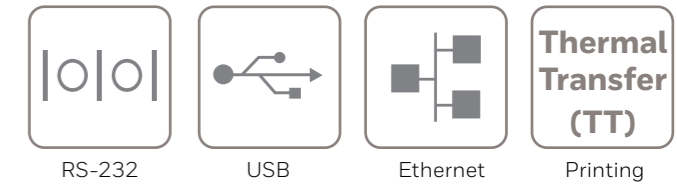

PM45C SHORT DOOR FEATURE OVERVIEW

Rewinder + Label Taken Sensor - Full Touch Display - Thermal Transfer



PM45C - Full Touch - Short Door - Internal Rewind + Label Taken Sensor - Thermal Transfer - 203 DPI

PM45CA1010030200 PM45 Compact, Full Touch Display, Ethernet, Short Door, Fixed Hanger, Rewinder + Label Taken Sensor, Real Time Clock (RTC), Thermal Transfer (TT), 203 DPI, No Power Cord

PM45C - Full Touch - Short Door - Internal Rewind + Label Taken Sensor - Thermal Transfer - 300 DPI

PM45CA1010030300 PM45 Compact, Full Touch Display, Ethernet, Short Door, Fixed Hanger, Rewinder + Label Taken Sensor, Real Time Clock (RTC), Thermal Transfer (TT), 300 DPI, No Power Cord

PM45C - Full Touch - Short Door - Internal Rewind + Label Taken Sensor - Thermal Transfer - 406 DPI

PM45CA1010030400 PM45 Compact, Full Touch Display, Ethernet, Short Door, Fixed Hanger, Rewinder + Label Taken Sensor, Real Time Clock (RTC), Thermal Transfer (TT), 406 DPI, No Power Cord

PM45C - Full Touch - Short Door - Internal Rewind + Label Taken Sensor - Thermal Transfer - 600 DPI

PM45CA1010030600 PM45 Compact, Full Touch Display, Ethernet, Short Door, Fixed Hanger, Rewinder + Label Taken Sensor, Real Time Clock (RTC), Thermal Transfer (TT), 600 DPI, No Power Cord

Included in the box:

- PM45C
- PM45C Regulatory Sheet (PM45-ML-RS-01)
- Collapsible Core

- Batch Plate (653-679-001) - Not installed in PM45C

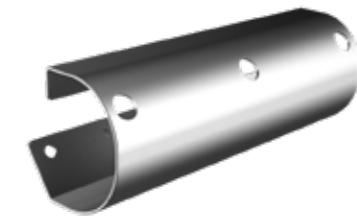

- No Power Cord

- Ribbon Core (048524)



Note: Not all printer combinations are available in every region. Check your local Price Book to see which part numbers are available for sale.

Honeywell Repair Services

SVC PM45-SG3N	PM45 / PM45C, Edge Service, Gold Maintenance Contract, 3 Year, New Contract
ADD SVCPRINTHEAD-PRN3	AddOn, Edge Service, Printhead Refresh Service, 203 or 300 DPI, 3-Year Contract
ADD SVCACC-PRN3	AddOn, Edge Service, Accessory Service, Printer, 3 Year

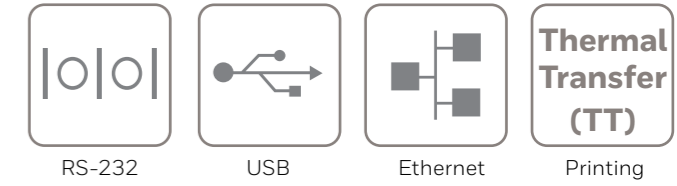

PM45C LONG DOOR FEATURE OVERVIEW

Tear Off - Full Touch Display - Thermal Transfer



PM45C - Full Touch - Long Door - Thermal Transfer - 203 DPI

PM45CA1000000200 PM45 Compact, Full Touch Display, Ethernet, Long Door, Fixed Hanger, Real Time Clock (RTC), Thermal Transfer (TT), 203 DPI, No Power Cord

PM45C - Full Touch - Long Door - Thermal Transfer - 300 DPI

PM45CA1000000300 PM45 Compact, Full Touch Display, Ethernet, Long Door, Fixed Hanger, Real Time Clock (RTC), Thermal Transfer (TT), 300 DPI, No Power Cord

PM45C - Full Touch - Long Door - Thermal Transfer - 406 DPI

PM45CA1000000400 PM45 Compact, Full Touch Display, Ethernet, Long Door, Fixed Hanger, Real Time Clock (RTC), Thermal Transfer (TT), 406 DPI, No Power Cord

PM45C - Full Touch - Long Door - Thermal Transfer - 600 DPI

PM45CA1000000600 PM45 Compact, Full Touch Display, Ethernet, Long Door, Fixed Hanger, Real Time Clock (RTC), Thermal Transfer (TT), 600 DPI, No Power Cord

Included in the box:

- PM45C
- PM45C Regulatory Sheet (PM45-ML-RS-01)
- Collapsible Core



- No Power Cord

Note: Not all printer combinations are available in every region. Check your local Price Book to see which part numbers are available for sale.

Honeywell Repair Services

SVC PM45-SG3N	PM45 / PM45C, Edge Service, Gold Maintenance Contract, 3 Year, New Contract
ADD SVCPRINTHEAD-PRN3	AddOn, Edge Service, Printhead Refresh Service, 203 or 300 DPI, 3-Year Contract
ADD SVCACC-PRN3	AddOn, Edge Service, Accessory Service, Printer, 3 Year

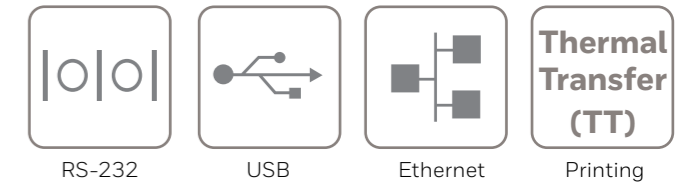

PM45C LONG DOOR FEATURE OVERVIEW

Tear Off - Icon Display - Thermal Transfer



PM45C - Icon - Long Door - Thermal Transfer - 203 DPI

PM45CA0000000200

PM45 Compact, Icon Display, Ethernet, Long Door, Fixed Hanger, Real Time Clock (RTC), Thermal Transfer (TT), 203 DPI, No Power Cord

Included in the box:

- PM45C
- PM45C Regulatory Sheet (PM45-ML-RS-01)
- Collapsible Core



- No Power Cord

Note: Not all printer combinations are available in every region. Check your local Price Book to see which part numbers are available for sale.

Honeywell Repair Services

SVCPM45-SG3N

PM45 / PM45C, Edge Service, Gold Maintenance Contract, 3 Year, New Contract

ADD SVCPRINTHEAD-PRN3

AddOn, Edge Service, Printhead Refresh Service, 203 or 300 DPI, 3-Year Contract

ADD SVCACC-PRN3

AddOn, Edge Service, Accessory Service, Printer, 3 Year

PM45C LONG DOOR FEATURE OVERVIEW

Tear Off - Icon Display - Direct Thermal

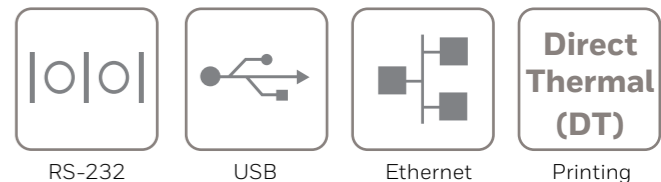

PM45C - Icon - Long Door - Direct Thermal - 203 DPI

PM45CA0000000210

PM45 Compact, Icon Display, Ethernet, Long Door, Fixed Hanger, Real Time Clock (RTC), Direct Thermal (DT), 203 DPI, No Power Cord

Included in the box:

- PM45C
- PM45C Regulatory Sheet (PM45-ML-RS-01)
- No Power Cord

Note: Not all printer combinations are available in every region. Check your local Price Book to see which part numbers are available for sale.

Honeywell Repair Services

SVCPM45-SG3N	PM45 / PM45C, Edge Service, Gold Maintenance Contract, 3 Year, New Contract
ADD SVCPRINHEAD-PRN3	AddOn, Edge Service, Printhead Refresh Service, 203 or 300 DPI, 3-Year Contract
ADD SVCACC-PRN3	AddOn, Edge Service, Accessory Service, Printer, 3 Year

PM45C LONG DOOR FEATURE OVERVIEW

Rewinder + Label Taken Sensor - Full Touch Display - Direct Thermal

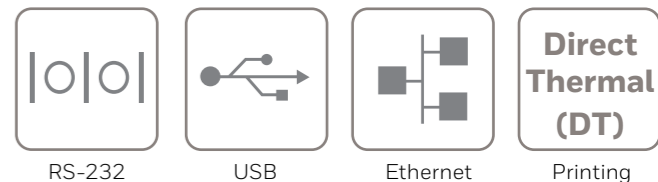

PM45C - Full Touch - Long Door - Internal Rewind + Label Taken Sensor - Direct Thermal - 203 DPI

PM45CA1000030210

PM45 Compact, Full Touch Display, Ethernet, Long Door, Fixed Hanger, Rewinder + Label Taken Sensor, Real Time Clock (RTC), Direct Thermal (DT), 203 DPI, No Power Cord

Included in the box:

- PM45C
- PM45C Regulatory Sheet (PM45-ML-RS-01)
- No Power Cord

- Batch Plate (653-679-001) - Not installed in PM45C

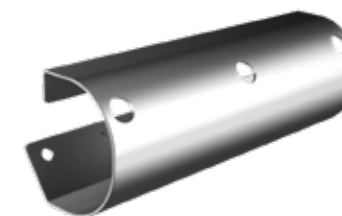

- Ribbon Core (048524)



Note: Not all printer combinations are available in every region. Check your local Price Book to see which part numbers are available for sale.

Honeywell Repair Services

SVCPM45-SG3N

PM45 / PM45C, Edge Service, Gold Maintenance Contract, 3 Year, New Contract

ADD SVCPRINHEAD-PRN3

AddOn, Edge Service, Printhead Refresh Service, 203 or 300 DPI, 3-Year Contract

ADD SVCACC-PRN3

AddOn, Edge Service, Accessory Service, Printer, 3 Year

PM45C LONG DOOR FEATURE OVERVIEW

Rewinder + Label Taken Sensor - Full Touch Display - Direct Thermal - WiFi/ Bluetooth (ROW)

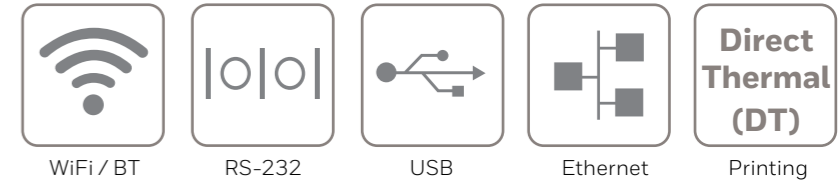

PM45C - Full Touch - Long Door - Internal Rewind + Label Taken Sensor - WiFi/ Bluetooth - Direct Thermal - 203 DPI

PM45CA1200030210

PM45 Compact, Full Touch Display, Ethernet, Bluetooth V5.0, WiFi Rest of World (ROW) IEEE 802.11 a/b/g/n/ac Long Door, Fixed Hanger, Rewinder + Label Taken Sensor, Real Time Clock (RTC), Direct Thermal (DT), 203 DPI, No Power Cord

Included in the box:

- PM45C
- PM45C Regulatory Sheet (PM45-ML-RS-01)
- No Power Cord

- Batch Plate (653-679-001) - Not installed in PM45C

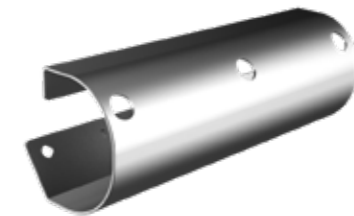

- Ribbon Core (048524)



Note: Not all printer combinations are available in every region. Check your local Price Book to see which part numbers are available for sale.

Honeywell Repair Services

SVCPM45-SG3N	PM45 / PM45C, Edge Service, Gold Maintenance Contract, 3 Year, New Contract
ADD SVCPRINHEAD-PRN3	AddOn, Edge Service, Printhead Refresh Service, 203 or 300 DPI, 3-Year Contract
ADD SVCACC-PRN3	AddOn, Edge Service, Accessory Service, Printer, 3 Year

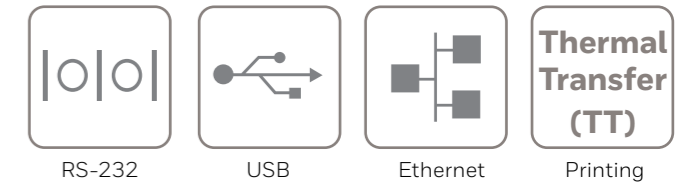

PM45C LONG DOOR FEATURE OVERVIEW

Rewinder + Label Taken Sensor – Full Touch Display – Thermal Transfer



PM45C - Full Touch - Long Door - Internal Rewind + Label Taken Sensor - Thermal Transfer - 203 DPI

PM45CA1000030200 PM45 Compact, Full Touch Display, Ethernet, Long Door, Fixed Hanger, Rewinder + Label Taken Sensor, Real Time Clock (RTC), Thermal Transfer (TT), 203 DPI, No Power Cord

PM45C - Full Touch - Long Door - Internal Rewind + Label Taken Sensor - Thermal Transfer - 300 DPI

PM45CA1000030300 PM45 Compact, Full Touch Display, Ethernet, Long Door, Fixed Hanger, Rewinder + Label Taken Sensor, Real Time Clock (RTC), Thermal Transfer (TT), 300 DPI, No Power Cord

PM45C - Full Touch - Long Door - Internal Rewind + Label Taken Sensor - Thermal Transfer - 406 DPI

PM45CA1000030400 PM45 Compact, Full Touch Display, Ethernet, Long Door, Fixed Hanger, Rewinder + Label Taken Sensor, Real Time Clock (RTC), Thermal Transfer (TT), 406 DPI, No Power Cord

PM45C - Full Touch - Long Door - Internal Rewind + Label Taken Sensor - Thermal Transfer - 600 DPI

PM45CA1000030600 PM45 Compact, Full Touch Display, Ethernet, Long Door, Fixed Hanger, Rewinder + Label Taken Sensor, Real Time Clock (RTC), Thermal Transfer (TT), 600 DPI, No Power Cord

Included in the box:

- PM45C
- PM45C Regulatory Sheet (PM45-ML-RS-01)
- Collapsible Core

- Batch Plate (653-679-001) - Not installed in PM45C

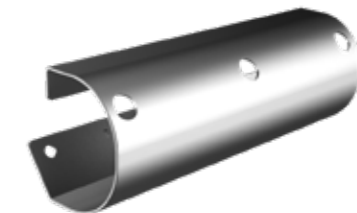

- No Power Cord

- Ribbon Core (048524)



Note: Not all printer combinations are available in every region. Check your local Price Book to see which part numbers are available for sale.

Honeywell Repair Services

SVCPM45-SG3N

PM45 / PM45C, Edge Service, Gold Maintenance Contract, 3 Year, New Contract

ADD SVCPRINTHEAD-PRN3

AddOn, Edge Service, Printhead Refresh Service, 203 or 300 DPI, 3-Year Contract

ADD SVCACC-PRN3

AddOn, Edge Service, Accessory Service, Printer, 3 Year

PM45C LONG DOOR FEATURE OVERVIEW

Rewinder + Label Taken Sensor - Icon Display - Thermal Transfer

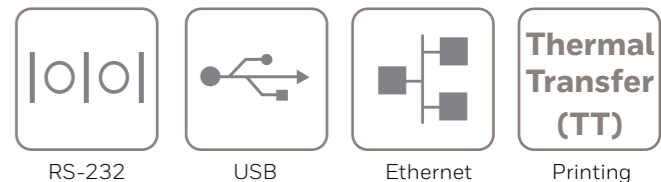

PM45C - Icon - Long Door - Internal Rewind + Label Taken Sensor - Thermal Transfer - 203 DPI

PM45CA0000030200

PM45 Compact, Icon Display, Ethernet, Long Door, Fixed Hanger, Rewinder + Label Taken Sensor, Real Time Clock (RTC), Thermal Transfer (TT), 203 DPI, No Power Cord

Included in the box:

- PM45C
- PM45C Regulatory Sheet (PM45-ML-RS-01)
- Collapsible Core

- Batch Plate (653-679-001) - Not installed in PM45C



- No Power Cord

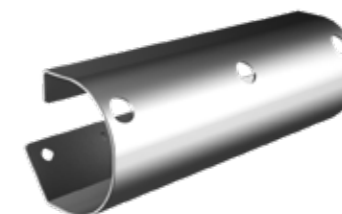

- Ribbon Core (048524)



Note: Not all printer combinations are available in every region. Check your local Price Book to see which part numbers are available for sale.

Honeywell Repair Services

SVCPM45-SG3N

PM45 / PM45C, Edge Service, Gold Maintenance Contract, 3 Year, New Contract

ADD SVCPRINTHEAD-PRN3

AddOn, Edge Service, Printhead Refresh Service, 203 or 300 DPI, 3-Year Contract

ADD SVCACC-PRN3

AddOn, Edge Service, Accessory Service, Printer, 3 Year

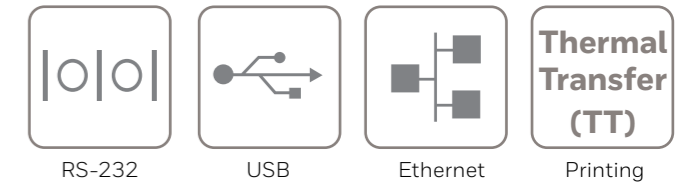

PM45C MEGA DOME DOOR FEATURE OVERVIEW

Tear Off - Full Touch Display - Thermal Transfer



PM45C - Full Touch - Mega Dome Door - Thermal Transfer - 203 DPI

PM45CA1020000200 PM45 Compact, Full Touch Display, Ethernet, Mega Dome Door, Fixed Hanger, Real Time Clock (RTC), Thermal Transfer (TT), 203 DPI, No Power Cord

PM45C - Full Touch - Mega Dome Door - Thermal Transfer - 300 DPI

PM45CA1020000300 PM45 Compact, Full Touch Display, Ethernet, Mega Dome Door, Fixed Hanger, Real Time Clock (RTC), Thermal Transfer (TT), 300 DPI, No Power Cord

PM45C - Full Touch - Mega Dome Door - Thermal Transfer - 406 DPI

PM45CA1020000400 PM45 Compact, Full Touch Display, Ethernet, Mega Dome Door Fixed Hanger, Real Time Clock (RTC), Thermal Transfer (TT), 406 DPI, No Power Cord

PM45C - Full Touch - Mega Dome Door - Thermal Transfer - 600 DPI

PM45CA1020000600 PM45 Compact, Full Touch Display, Ethernet, Mega Dome Door, Fixed Hanger, Real Time Clock (RTC), Thermal Transfer (TT), 600 DPI, No Power Cord

Included in the box:

- PM45C
- PM45C Regulatory Sheet (PM45-ML-RS-01)
- Collapsible Core



- No Power Cord

Note: Not all printer combinations are available in every region. Check your local Price Book to see which part numbers are available for sale.

Honeywell Repair Services

SVC PM45-SG3N	PM45 / PM45C, Edge Service, Gold Maintenance Contract, 3 Year, New Contract
ADD SVCPRINHEAD-PRN3	AddOn, Edge Service, Printhead Refresh Service, 203 or 300 DPI, 3-Year Contract
ADD SVCACC-PRN3	AddOn, Edge Service, Accessory Service, Printer, 3 Year

PM45C MEGA DOME DOOR FEATURE OVERVIEW

Tear Off - Icon Display - Thermal Transfer

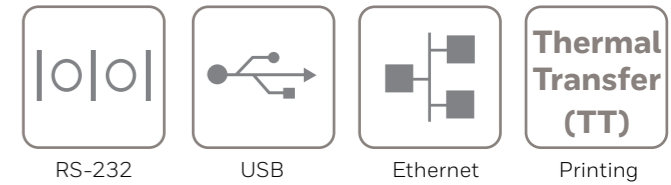

PM45C - Icon - Mega Dome Door - Thermal Transfer - 203 DPI

PM45CA0020000200

PM45 Compact, Icon Display, Ethernet, Mega Dome Door, Fixed Hanger, Real Time Clock (RTC), Thermal Transfer (TT), 203 DPI, No Power Cord

Included in the box:

- PM45C
- PM45C Regulatory Sheet (PM45-ML-RS-01)
- Collapsible Core



- No Power Cord

Note: Not all printer combinations are available in every region. Check your local Price Book to see which part numbers are available for sale.

Honeywell Repair Services

SVCPM45-SG3N	PM45 / PM45C, Edge Service, Gold Maintenance Contract, 3 Year, New Contract
ADD SVCPRINHEAD-PRN3	AddOn, Edge Service, Printhead Refresh Service, 203 or 300 DPI, 3-Year Contract
ADD SVCACC-PRN3	AddOn, Edge Service, Accessory Service, Printer, 3 Year

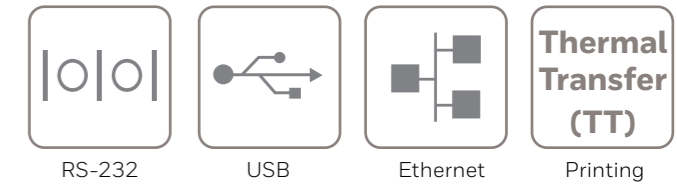

PM45C MEGA DOME DOOR FEATURE OVERVIEW

Rewinder + Label Taken Sensor - Full Touch Display - Thermal Transfer



PM45C - Full Touch - Mega Dome Door - Internal Rewind + Label Taken Sensor - Thermal Transfer - 203 DPI

PM45CA1020030200 PM45 Compact, Full Touch Display, Ethernet, Mega Dome Door, Fixed Hanger, Rewinder + Label Taken Sensor, Real Time Clock (RTC), Thermal Transfer (TT), 203 DPI, No Power Cord

PM45C - Full Touch - Mega Dome Door - Internal Rewind + Label Taken Sensor - Thermal Transfer - 300 DPI

PM45CA1020030300 PM45 Compact, Full Touch Display, Ethernet, Mega Dome Door, Fixed Hanger, Rewinder + Label Taken Sensor, Real Time Clock (RTC), Thermal Transfer (TT), 300 DPI, No Power Cord

PM45C - Full Touch - Mega Dome Door - Internal Rewind + Label Taken Sensor - Thermal Transfer - 406 DPI

PM45CA1020030400 PM45 Compact, Full Touch Display, Ethernet, Mega Dome Door, Fixed Hanger, Rewinder + Label Taken Sensor, Real Time Clock (RTC), Thermal Transfer (TT), 406 DPI, No Power Cord

PM45C - Full Touch - Mega Dome Door - Internal Rewind + Label Taken Sensor - Thermal Transfer - 600 DPI

PM45CA1020030600 PM45 Compact, Full Touch Display, Ethernet, Mega Dome Door, Fixed Hanger, Rewinder + Label Taken Sensor, Real Time Clock (RTC), Thermal Transfer (TT), 600 DPI, No Power Cord

Included in the box:

- PM45C
- PM45C Regulatory Sheet (PM45-ML-RS-01)
- Collapsible Core

- Batch Plate (653-679-001) - Not installed in PM45C

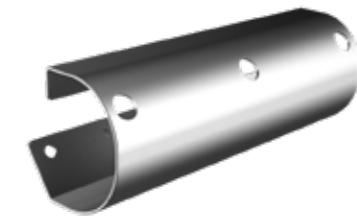

- No Power Cord

- Ribbon Core (048524)



Note: Not all printer combinations are available in every region. Check your local Price Book to see which part numbers are available for sale.



Honeywell Repair Services

SVCPM45-SG3N	PM45 / PM45C, Edge Service, Gold Maintenance Contract, 3 Year, New Contract
ADD SVCPRINTHEAD-PRN3	AddOn, Edge Service, Printhead Refresh Service, 203 or 300 DPI, 3-Year Contract
ADD SVCACC-PRN3	AddOn, Edge Service, Accessory Service, Printer, 3 Year

PM45C CONFIGURATION MAP

Compact Industrial Printer

VERSION
USER INTERFACE
CONNECTIVITY
MEDIA COVER
I/O OPTION 1
OPTION 1
MEDIA HANDLING
PRINT OPTION
POWER CORD

PM45C								DESCRIPTION	NOTES
A								Standard	1 x USB A Port (USB 2.0 Host), 1 x USB B Port (USB 2.0 Device), 1 x DB9F (RS-232, up to 115.2 KB/s), Real Time Clock (RTC)
	0							Icon User Interface	
	1							Full Touch User Interface	
	2							Icon User Interface + Bluetooth Low Energy (BLE)	Bluetooth Low Energy (BLE) used for communication with Printset MC Application
	3							Full Touch User Interface + Bluetooth Low Energy (BLE)	Bluetooth Low Energy (BLE) used for communication with Printset MC Application
		0						Ethernet	Ethernet 10/100/1000 Mbps
		1						Ethernet + WLAN North America (NA) + Bluetooth	Available as Kit - Part# 50178327-001 WiFi 802.11 a/b/g/n/ac + V5.0 Bluetooth Kit (North America)
		2						Ethernet + WLAN Rest Of World (ROW) + Bluetooth	Available as Kit - Part# 50174832-001 WiFi 802.11 a/b/g/n/ac + V5.0 Bluetooth Kit (Rest Of World)
			0					Long Door	
			1					Short Door	
			2					Mega Dome Door	
				00				None	
				01				Parallel Interface	Available as Kit - Part# PM45-PAR-01 PARALLEL IEEE 1284 INTERFACE PM45
				02				Industrial Interface	Available as Kit - Part# PM45-IND-01 UART + INDUSTRIAL INTERFACE PM45
				03				Applicator Interface	Available as Kit - Part# PM45-APPL-01 APPLICATOR INTERFACE PM45
				EU				UHF RFID Europe (EU) - 869MHz	Available as Kit - Part# 50180233-001 RFID IM11 INTERFACE EU/ ROW,ASSY,PM45
				NA				UHF RFID North America (NA) - 915MHz	Available as Kit - Part# 50180747-001 RFID IM11 INTERFACE NA,ASSY,PM45
					0			None	
					1			Label Taken Sensor (LTS)	Available as Kit - Part# 715-616S-001 Label Taken Sensor (LTS), Spare Kit, PM43/ PM45
					2			Rewinder	Available as Kit - Part# 50178326-001 PM45 Rewinder,Media Internal Sub-Assembly
					3			Rewinder + Label Taken Sensor (LTS)	Available as Kit - Part# 50178326-001 PM45 Rewinder,Media Internal Sub-Assembly + Part# 715-616S-001 Label Taken Sensor (LTS), PM45
						0		Fixed Hanger	
						1		Rotating Hanger	Available as Kit - Part# 203-977-001 KIT, ROTATION HANGER + Part# 203-972-001 - 3 inch Media Core
						20		Thermal Transfer (TT) 203 DPI	Available as Kit - Part# 50180236-001 PRINTHEAD ASSY 203 DPI,PM45/PM45C
						21		Direct Thermal (DT) 203 DPI	Available as Kit - Part# 50180236-001 PRINTHEAD ASSY 203 DPI,PM45/PM45C
						30		Thermal Transfer (TT) 300 DPI	Available as Kit - Part# 50180237-001 PRINTHEAD ASSY 300 DPI,PM45/PM45C
						31		Direct Thermal (DT) 300 DPI	Available as Kit - Part# 50180237-001 PRINTHEAD ASSY 300 DPI,PM45/PM45C
						40		Thermal Transfer (TT) 406 DPI	Available as Kit - Part# 50180238-001 PRINTHEAD ASSY 406 DPI,PM45/PM45C
						41		Direct Thermal (DT) 406 DPI	Available as Kit - Part# 50180238-001 PRINTHEAD ASSY 406 DPI,PM45/PM45C
						60		Thermal Transfer (TT) 600 DPI	Available as Kit - Part# 50180234-001 PRINTHEAD ASSY 600 DPI,PM45/PM45C
						61		Direct Thermal (DT) 600 DPI	Available as Kit - Part# 50180234-001 PRINTHEAD ASSY 600 DPI,PM45/PM45C
							0	None	AC Power Cord C13 Type Connector
							1	US Power Cord	AC Power Cord C13 Type Connector
							2	EU Power Cord	AC Power Cord C13 Type Connector
							6	India Power Cord	AC Power Cord C13 Type Connector



HONEYWELL EDGE SERVICES

PM45 / PM45C – Repair Services

Honeywell Edge Services give you the confidence of having leading-class technologies combined with service and support plans that are designed to keep you operational for longer.

Gold Repair Services – 3 Year

The most flexible contract in the industry. The Edge Services Gold Support contract allows you to select the right coverage for your organization, and includes 5-Day Depot Repairs and:

Service Overview

- Repair or replacement of damaged components, wear and tear, and accidental damage.
- Flexibility to add any Add-On Service

PART NUMBER	DESCRIPTION
SVCPM45-SG3N	PM45/ PM45C, Edge Service, GOLD Maintenance Contract, 5 Day Turnaround, 3 Year , New Contract

Add-On Accessory Replacement Service

Provides replacement cables, interface cards or platen rollers should they be damaged or stop working.

ADD SVCACC-PRN3	AddOn, Edge Service, Accessory Service , Printer, 3 Year
------------------------	---

Add-On Printhead Refresh Service

Provides replacement 203 or 300 DPI printhead at 18 months after purchase.

ADD SVCPRINTHEAD-PRN3	AddOn, Edge Service, Printhead Refresh Service, 200 or 300 dpi, 3 Year , 1 replacement printhead
------------------------------	---

Add-On Device Replacement Service

Replacement devices should a device be damaged beyond repair.

ADD SVCREPLACE-PRN3	AddOn, Edge Service, Device Replacement, Printer, 3 Year
----------------------------	---

Add-On Cutter Replacement Service

Provides replacement cutters should they be damaged or stop working.

ADD SVCCUTTER1-PRN3	AddOn, Edge Service, Cutter Service for Printers, 3 Year
----------------------------	---

Add-On Spare Management Service

Manages every aspect of your spare pool.

ADD SVCSPAREMGMT-PRN3	AddOn, Edge Service, Advanced Exchange, Printer, 3 Year . Customer owned spare pool, Minimum Purchase required, contact your local Honeywell Service Representative for more information.
------------------------------	--

Add-On 2-Day Turnaround Depot Upgrade

Upgrade your Gold Maintenance Contract from 5-Day to 2-Day turnaround at the repair depot.

ADD SVC2DAYDEPOT-PRN3	AddOn, Edge Service, 2-Day Depot Upgrade, 3-Year Agreement, Requires purchase of a 3 Year Gold Maintenance Contract.
------------------------------	---

Platinum Repair Services – 3 Year

The Edge Services Platinum Support contract is the only total support contract in the industry today offering 2-Day Depot Repairs or Spare Pool Management with 3-year contract, that includes:

Service Overview

- Repair or replacement of damaged components
- SVCREPLACE-PRN3 - Replacement devices should a device be damaged beyond repair
- SVCACC-PRN3 - Accessory replacement service
- SVCPRINTHEAD-PRN3 - Provides replacement 203 or 300 DPI printhead at 18 months after purchase.
- SVCSPAREMGMT-PRN3 - Spare pool management (optional, minimum quantity required)
- SVCCUTTER1-PRN3 - Provides replacement cutters should they be damaged or stop working.
- Telephone-based technical support

PART NUMBER	DESCRIPTION
SVCPM45-SP3N	PM45/PM45C, Edge Service, PLATINUM, 2 Day Turnaround, 3 Year, New Contract



HONEYWELL EDGE SERVICES

PM45 / PM45C – Repair Services

Honeywell Edge Services give you the confidence of having leading-class technologies combined with service and support plans that are designed to keep you operational for longer.

Gold Repair Services – 5 Year

The most flexible contract in the industry. The Edge Services Gold Support contract allows you to select the right coverage for your organization, and includes 5-Day Depot Repairs and:

Service Overview

- Repair or replacement of damaged components, wear and tear, and accidental damage.
- Flexibility to add any Add-On Service

PART NUMBER	DESCRIPTION
SVCPM45-SG5N	PM45/ PM45C, Edge Service, GOLD Maintenance Contract, 5 Day Turnaround, 5 Year , New Contract

Add-On Accessory Replacement Service

Provides replacement cables, interface cards or platen rollers should they be damaged or stop working.

ADD SVCACC-PRN5	AddOn, Edge Service, Accessory Service , Printer, 5 Year
------------------------	---

Add-On Printhead Refresh Service

Provides replacement 203 or 300 DPI printhead at 18 and 36 months after purchase.

ADD SVCPRINTHEAD-PRN5	AddOn, Edge Service, Printhead Refresh Service, 200 or 300 dpi, 5 Year , 2 replacement printheads
------------------------------	--

Add-On Device Replacement Service

Replacement devices should a device be damaged beyond repair.

ADD SVCREPLACE-PRN5	AddOn, Edge Service, Device Replacement, Printer, 5 Year
----------------------------	---

Add-On Cutter Replacement Service

Provides replacement cutters should they be damaged or stop working.

ADD SVCCUTTER1-PRN5	AddOn, Edge Service, Cutter Service for Printers, 5 Year
----------------------------	---

Add-On Spare Management Service

Manages every aspect of your spare pool.

ADD SVCSPAREMGMT-PRN5	AddOn, Edge Service, Advanced Exchange, Printer, 5 Year . Customer owned spare pool, Minimum Purchase required, contact your local Honeywell Service Representative for more information.
------------------------------	--

Add-On 2-Day Turnaround Depot Upgrade

Upgrade your Gold Maintenance Contract from 5-Day to 2-Day turnaround at the repair depot.

ADD SVC2DAYDEPOT-PRN5	AddOn, Edge Service, 2-Day Depot Upgrade, 3-Year Agreement, Requires purchase of a 5 Year Gold Maintenance Contract.
------------------------------	---

Platinum Repair Services – 5 Year

The Edge Services Platinum Support contract is the only total support contract in the industry today offering 2-Day Depot Repairs or Spare Pool Management with 5-year contract, that includes:

Service Overview

- Repair or replacement of damaged components
- SVCREPLACE-PRN5 - Replacement devices should a device be damaged beyond repair
- SVCACC-PRN5 - Accessory replacement service
- SVCPRINTHEAD-PRN5 - Provides replacement 203 or 300 DPI printhead at 18 and 36 months after purchase.
- SVCSPAREMGMT-PRN5 - Spare pool management (optional, minimum quantity required)
- SVCCUTTER1-PRN5 - Provides replacement cutters should they be damaged or stop working.
- Telephone-based technical support

PART NUMBER	DESCRIPTION
SVCPM45-SP5N	PM45/PM45C, Edge Service, PLATINUM, 2 Day Turnaround, 5 Year, New Contract



HONEYWELL REPAIR SERVICES

PM45/ PM45C- Repair Services Coverage

For Best-In-Class Service



PM45



PM45C

Warranty Cover Against Product Defect

BASIC Service

Gold Coverage:

- Accidental Damage
- Wear & Tear

Includes Replacement of:

- Platen Roller



Flexible GOLD Add-Ons ordered separately

- SVCACC-PRN3 Accessories
- SVCPRINTHEAD-PRN3 Printhead Replacement
- SVCREPLACE-PRN3 Device Replacement
- SVCCUTTER1-PRN3 Cutter Replacement
- SVCSPAREMGMT-PRN3 Advanced Exchange

GOLD Service

Platinum Coverage

- Printhead Replacement
- Coverage for Cables and Interface Cards
- Cutter Replacement

- Accidental Damage
- Device Replacement
- Wear & Tear



Printhead
(3 Year – 1 replacement printhead)
(5 Year – 2 replacement printheads)



Cutter



I/O Cards

PLATINUM Service

PART NUMBER	DESCRIPTION
SVCPM45-EXW3	PM45/PM45C, BASIC, 10-15 Day Turnaround, 3 Years (1 Year Factory Warranty + 2 Year Extended)
SVCPM45-SG3N	PM45/PM45C, Edge Service, GOLD Maintenance Contract, 5 Day Turnaround, 3 Year, New Contract
ADD SVCACC-PRN3	AddOn, Edge Service, Accessory Service , Mobility, 3 Year.
ADD SVCPRINTHEAD-PRN3	AddOn, Edge Service, 203 or 300 DPI Printhead Refresh Service, 3-Year Contract, 1 replacement printhead
ADD SVCREPLACE-PRN3	AddOn, Edge Service, Device Replacement, Mobility, 3 Year
ADD SVCCUTTER1-PRN3	AddOn, Edge Service, Cutter Service for Printers, 3-Year
ADD SVCSPAREMGMT-PRN3	AddOn, Edge Service, Advanced Exchange, Mobility, 3 Year. Customer owned spare pool, Minimum Purchase required.
SVCPM45-SP3N	PM45/PM45C, Edge Service, PLATINUM, 2 Day Turnaround, 3 Year, New Contract

ACCESSORIES

PM45/ PM45C - I/O Cards

Expand your I/O with additional interface cards.

Warning: The I/O Cards must only be installed by an authorized service technician, as you need to open the printer and physically install the cards in the printer.



PM45 has 2 x I/O Expansion Slots



PART NUMBER	DESCRIPTION
PM45-IND-01	UART + INDUSTRIAL INTERFACE PM45

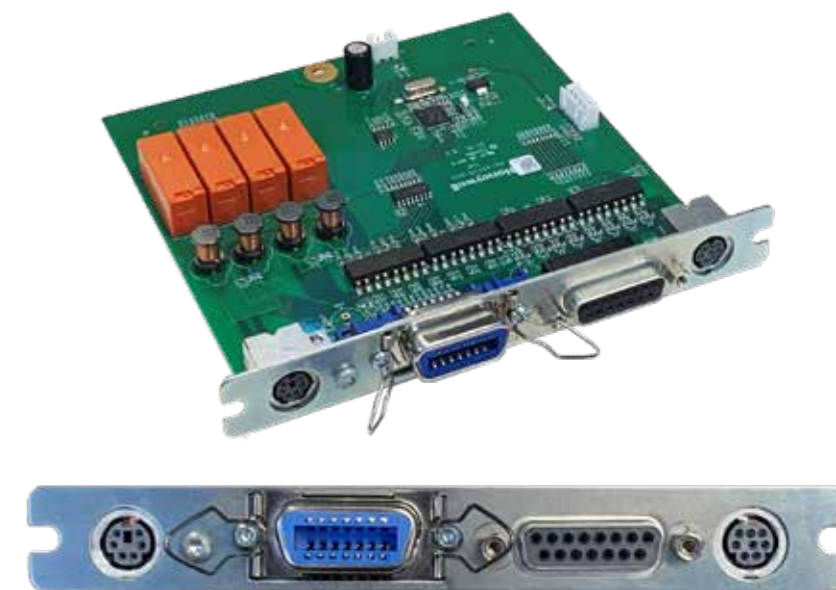

PART NUMBER	DESCRIPTION
PM45-APPL-01	APPLICATOR INTERFACE PM45



PM45C has 1 x I/O Expansion Slot

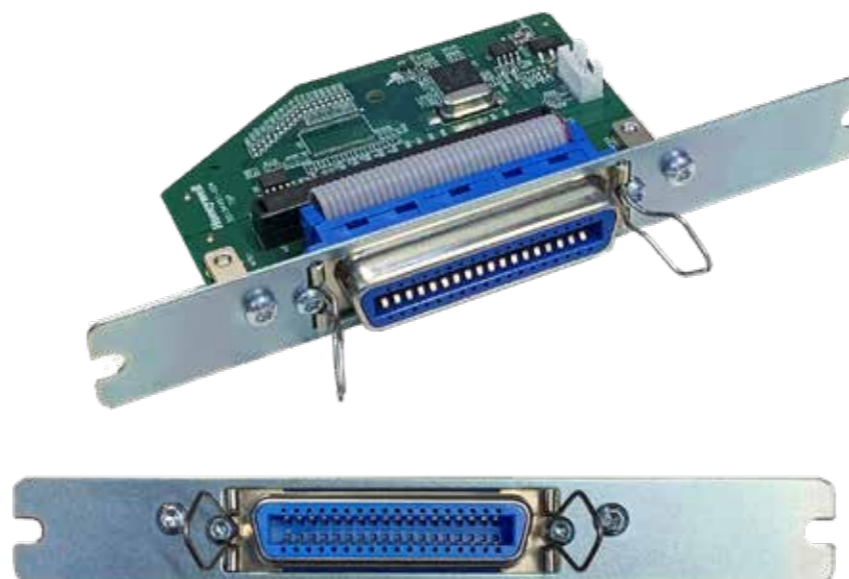

PART NUMBER	DESCRIPTION
PM45-PAR-01	KIT, PARALLEL PORT Use with Part# 1-974022-018 Parallel Cable

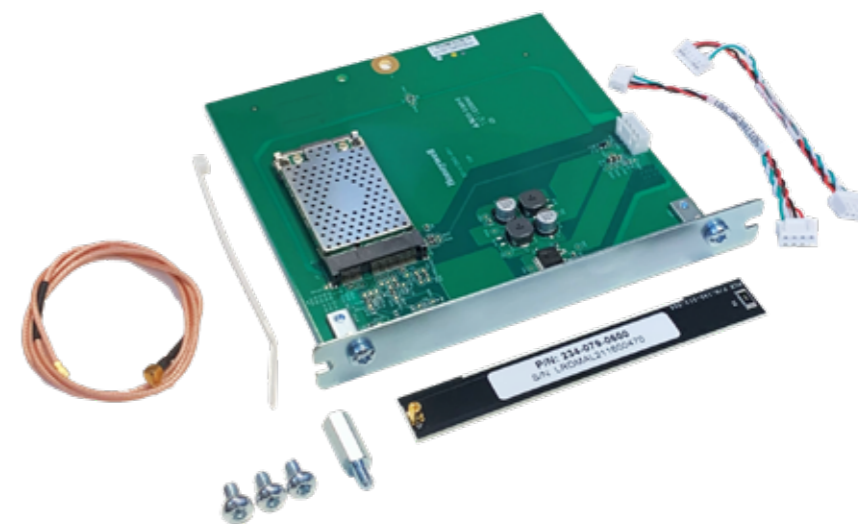

PART NUMBER	REGION	DESCRIPTION
50180747-001	North America	RFID IM11 INTERFACE NA,ASSY,PM45
50180233-001	EU / ROW	RFID IM11 INTERFACE EU/ ROW,ASSY,PM45

ACCESSORIES

PM45/ PM45C - WiFi and Bluetooth Card

The WiFi and Bluetooth card can be easily added to any PM45 or PM45C printer.



PM45 Rear I/O View



PART NUMBER	REGION	DESCRIPTION
50178327-001	North America	WiFi 802.11 a/b/g/n/ac + V5.0 Bluetooth Kit (North America)
50174832-001	EU / Rest Of World	WiFi 802.11 a/b/g/n/ac + V5.0 Bluetooth Kit (Rest Of World)

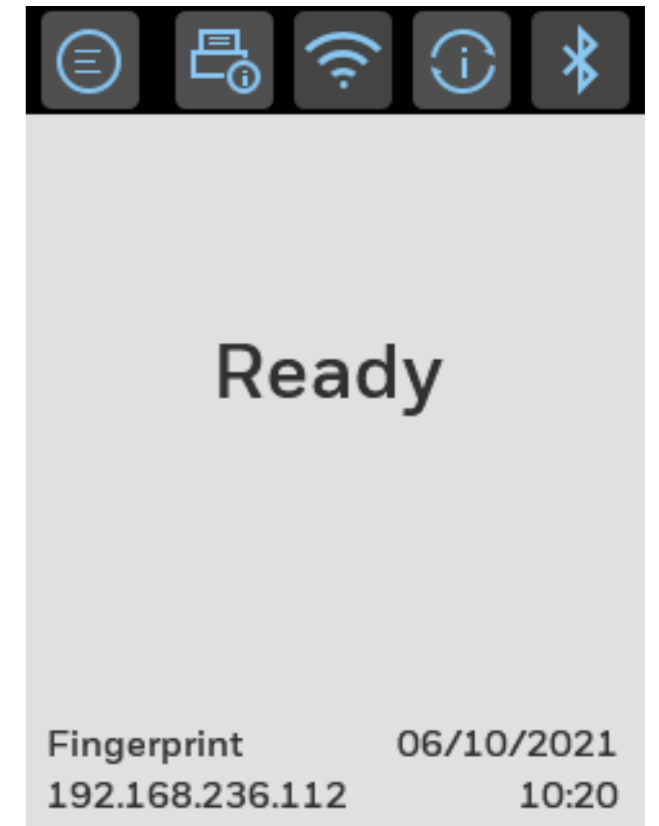

PM45C Rear I/O View

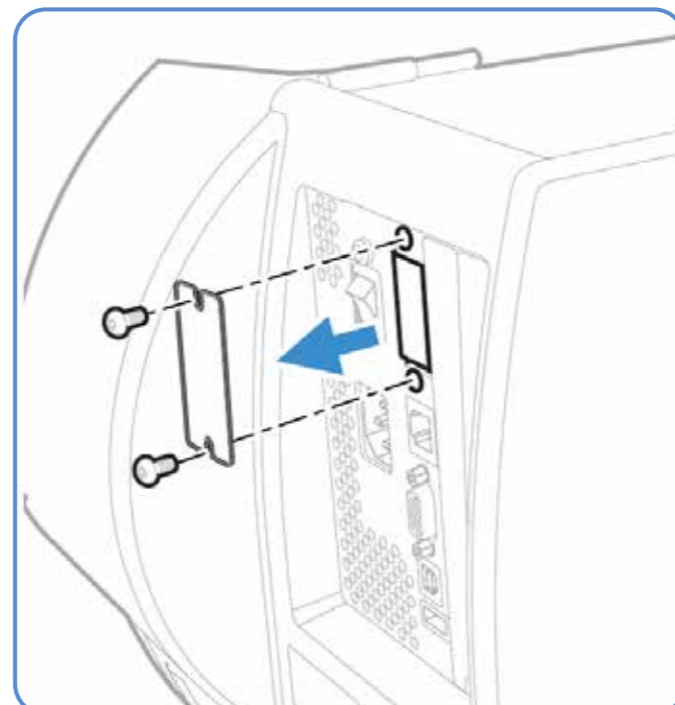

Remove cover plate

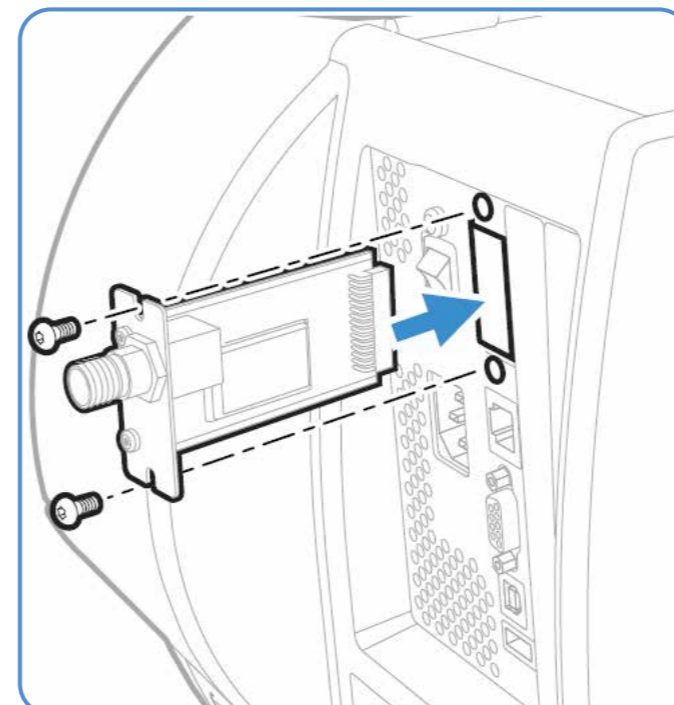

Insert WiFi/ Bluetooth board

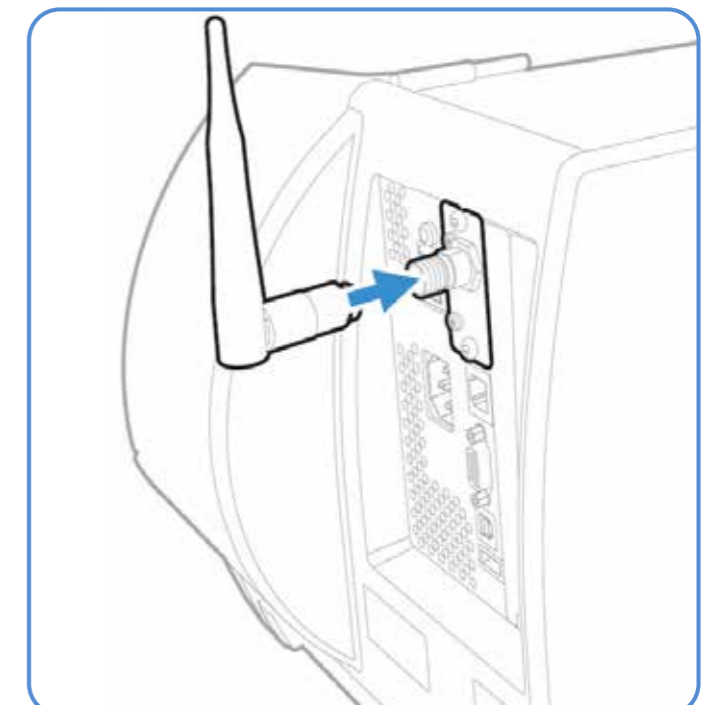

Connect antenna

ACCESSORIES

PM45/ PM45C - WWAN 4G LTE - Cellular Modem

Expand your I/O with additional interface cards. Note, the PM45 can only install this Modem Card on I/O slot 2, it is not compatible with slot 1.

Warning: The I/O Cards must only be installed by an authorized service technician, as you need to open the printer and physically install the cards in the printer.

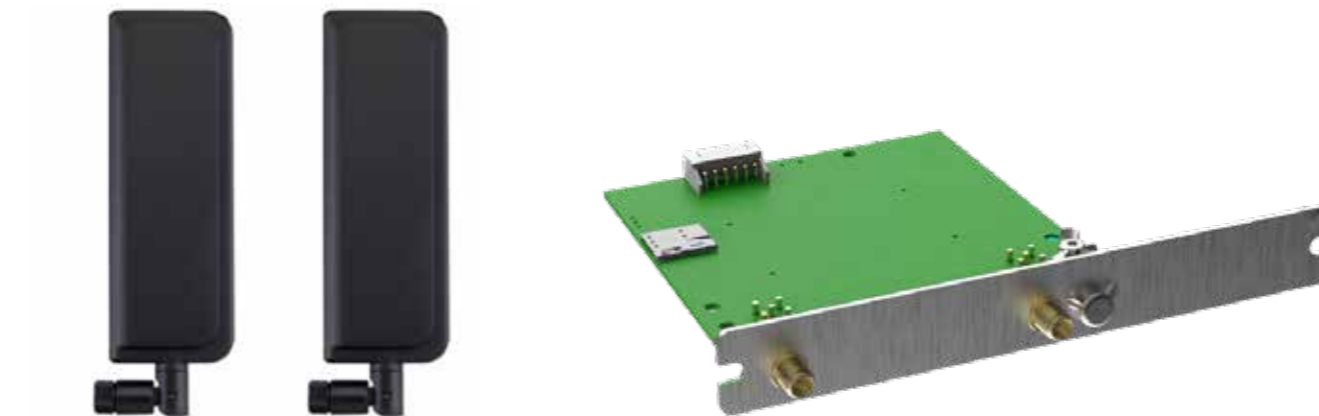
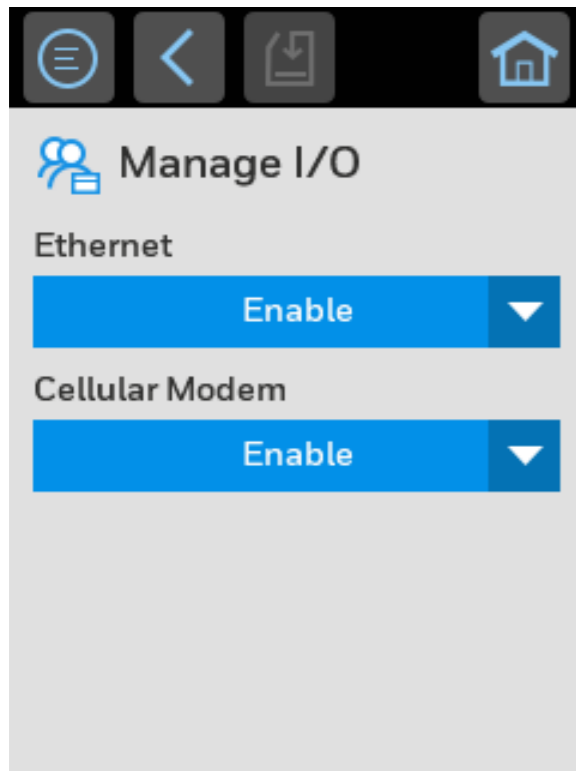

PART NUMBER	DESCRIPTION
50179990-001	Cellular Modem,Assy,PM45 (includes antennas)

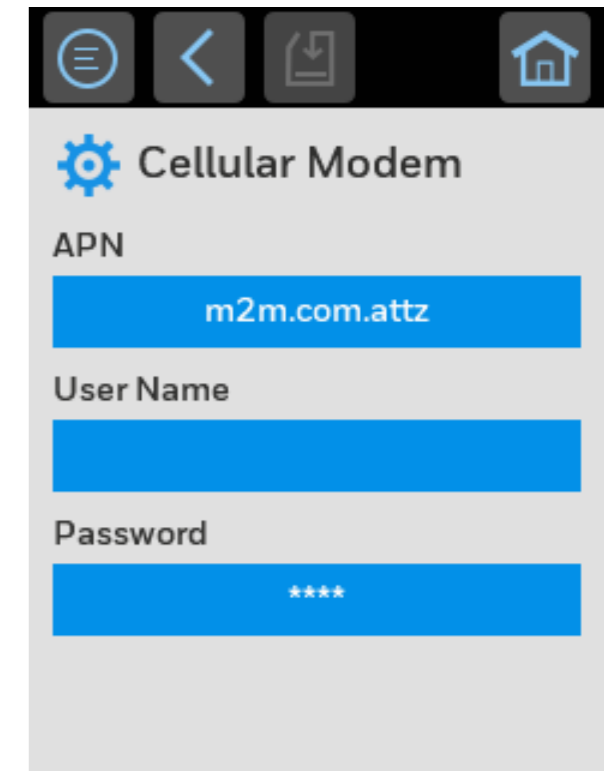

PM45 WWAN Rear I/O View

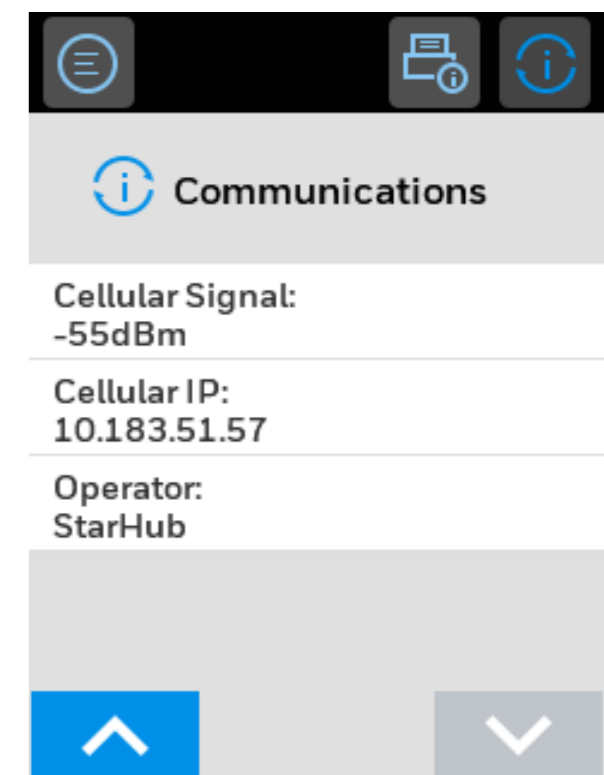
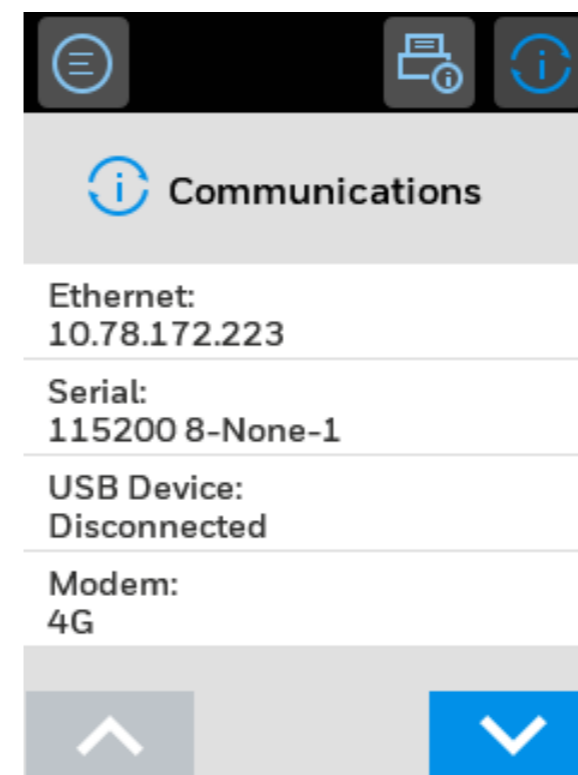
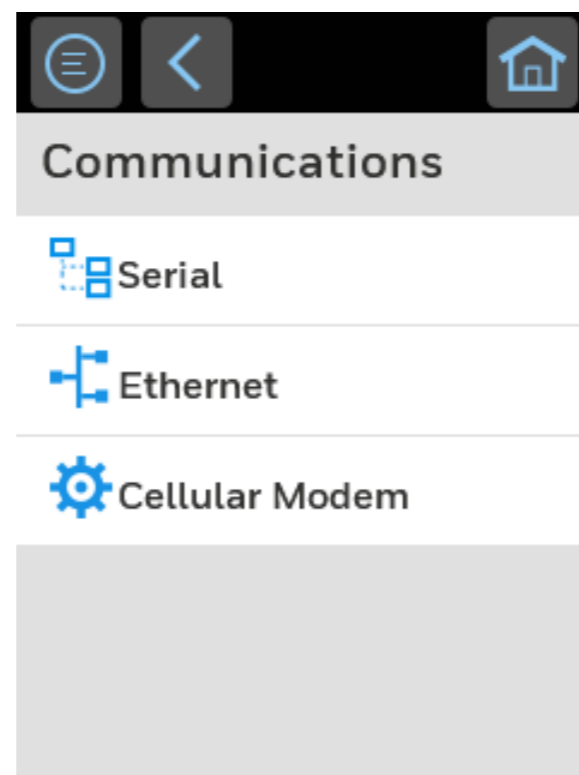

ACCESSORIES

PM45 Cutter

In cut-off printing, each label is automatically cut from the media roll immediately after the label is printed. You can print on non-adhesive, continuous label stock, and also self-adhesive labels with a liner.

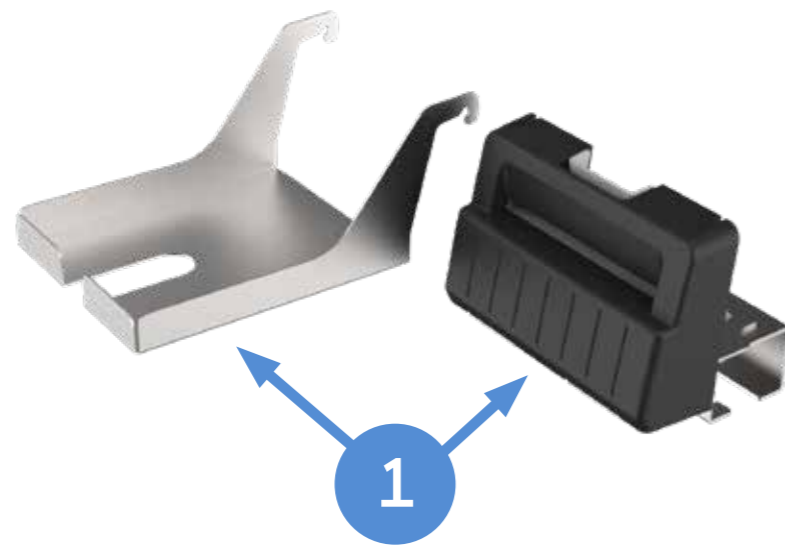

PART NUMBER	DESCRIPTION
1 50180206-001	Cutter Kit for PM45 (includes cutter tray)

PM45C Cutter

In cut-off printing, each label is automatically cut from the media roll immediately after the label is printed. You can print on non-adhesive, continuous label stock, and also self-adhesive labels with a liner. Optionally, a vertical tray can be added to the cutter, typically used in the airline industry.



Horizontal Tray installed

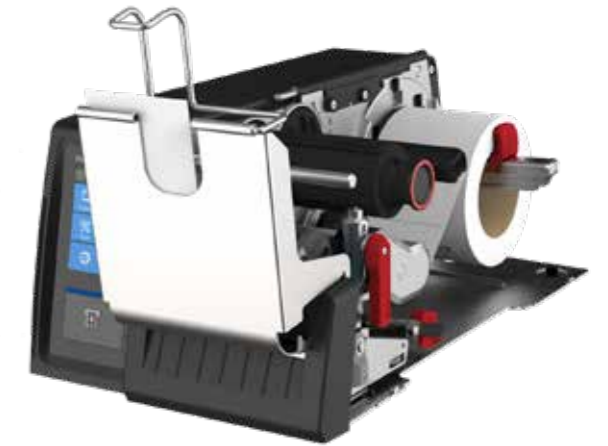

Vertical Tray installed

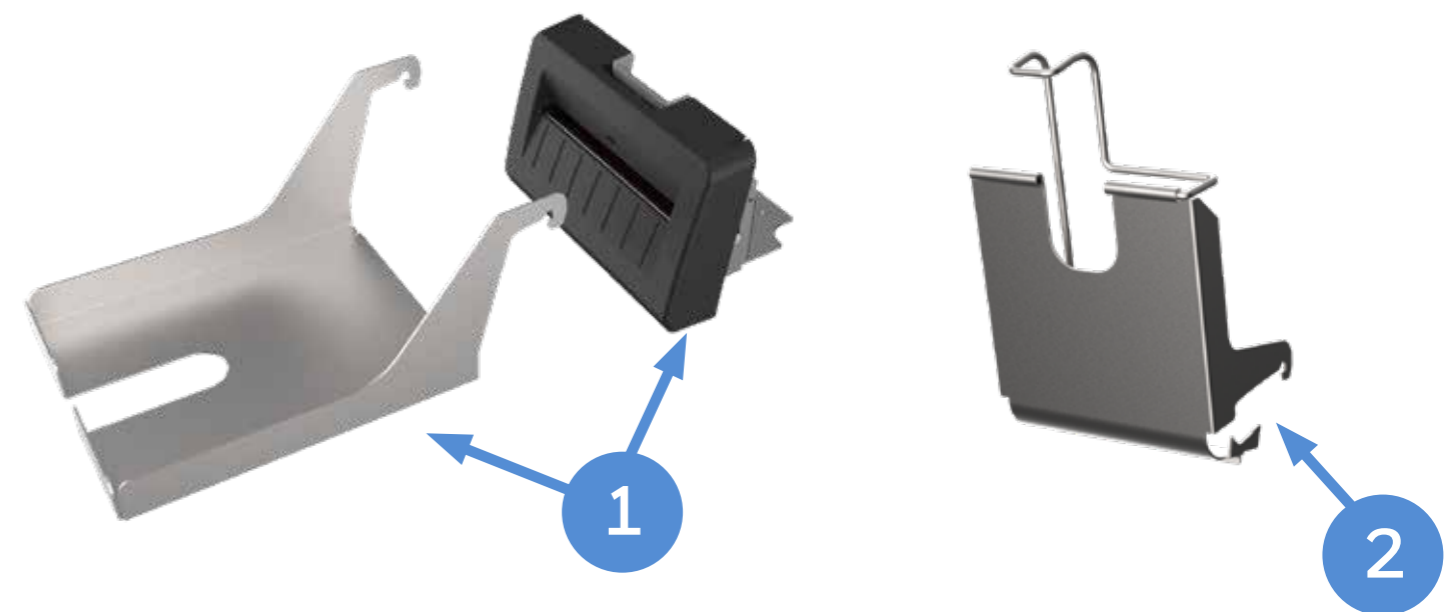

PART NUMBER	DESCRIPTION
1 50180201-001	Cutter Kit for PM45C (includes cutter tray)
2 203-993-001	Cutter Vertical Tray, Accessories Kits

ACCESSORIES

PM45/ PM45C Rotation Hanger

The rotation hanger enables consistent feeding of the media stock and also includes a low paper detection feature, recommended when large rolls of media are used or when printers are mounted on their side. It is compatible with both PM45 and PM45C printers.

Warning: The rotation hanger must only be installed by an authorized service technician, as you need to open the printer and physically install the hanger and media sensor in the printer.

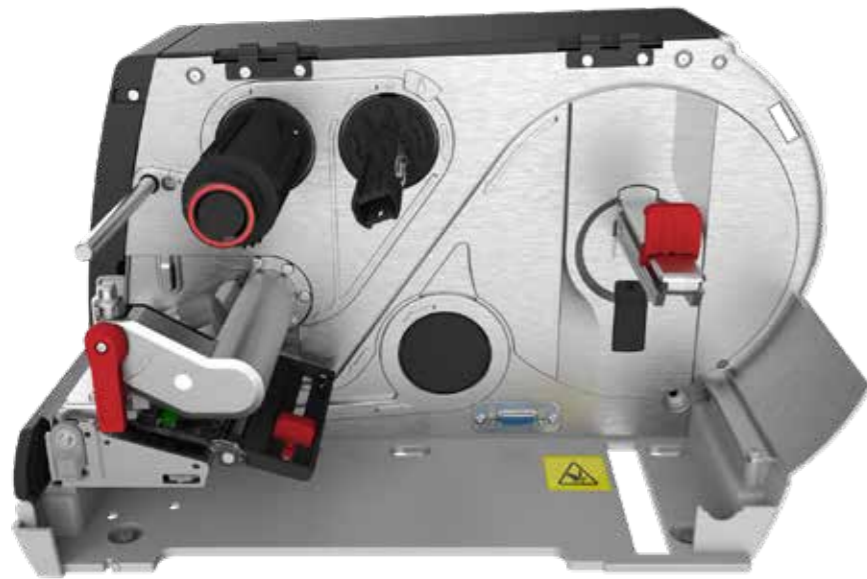

Standard Media Hanger

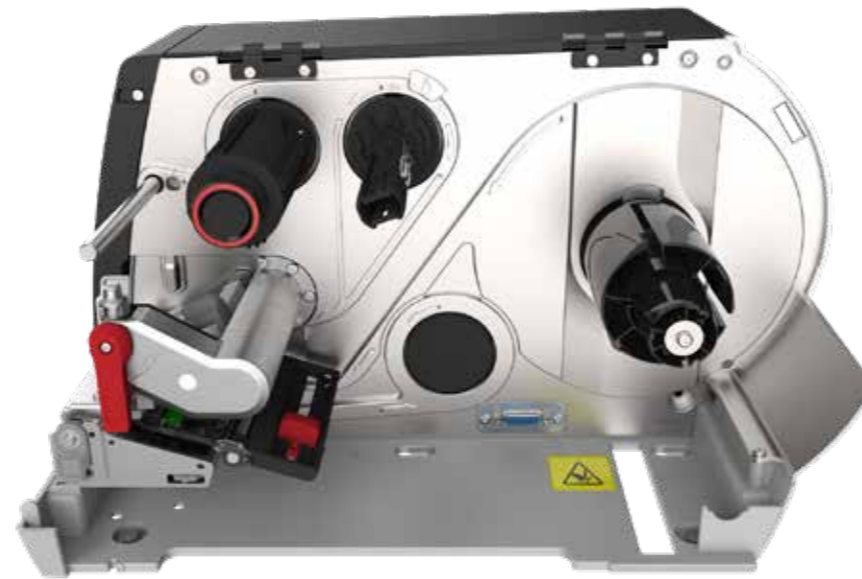

Rotation Hanger



Rotation Hanger with Media

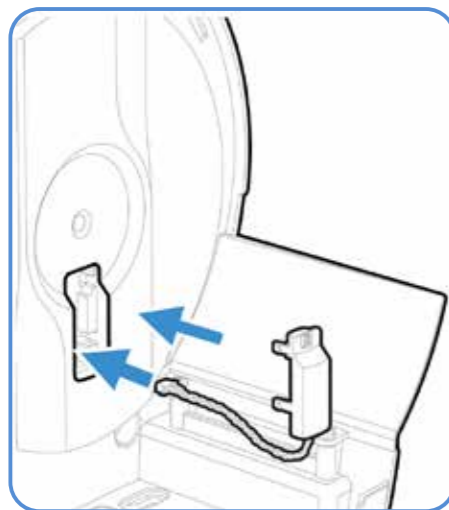

Media Sensor

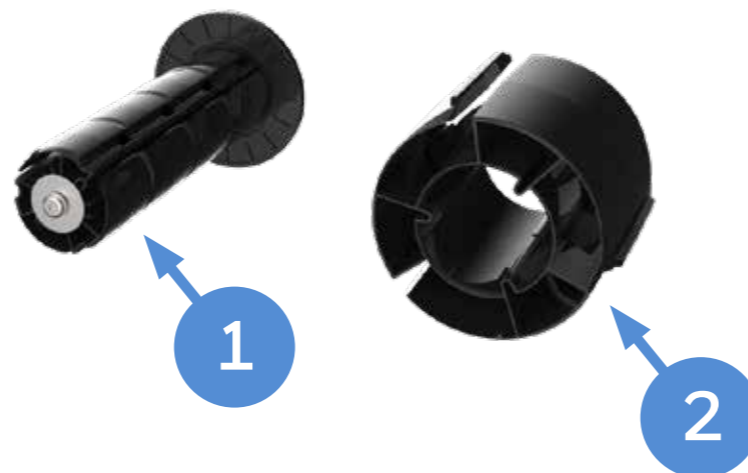

	PART NUMBER	DESCRIPTION
1	203-977-001	KIT, ROTATION HANGER (includes media sensor)
2	203-972-001	KIT, CORE 3 INCH (3 inch adapter (3' Dolly))

ACCESSORIES

Service Upgrade Kit - Internal Rewinder + Label Taken Sensor

This kit is for upgrading the PM45 or PM45C with the Internal Rewinder and Label Taken Sensor (LTS) option.

Warning: The Internal Rewinder and Label Taken Sensor must only be installed by an authorized service technician, as you need to open the printer and physically install the rewriter and sensor in the printer.

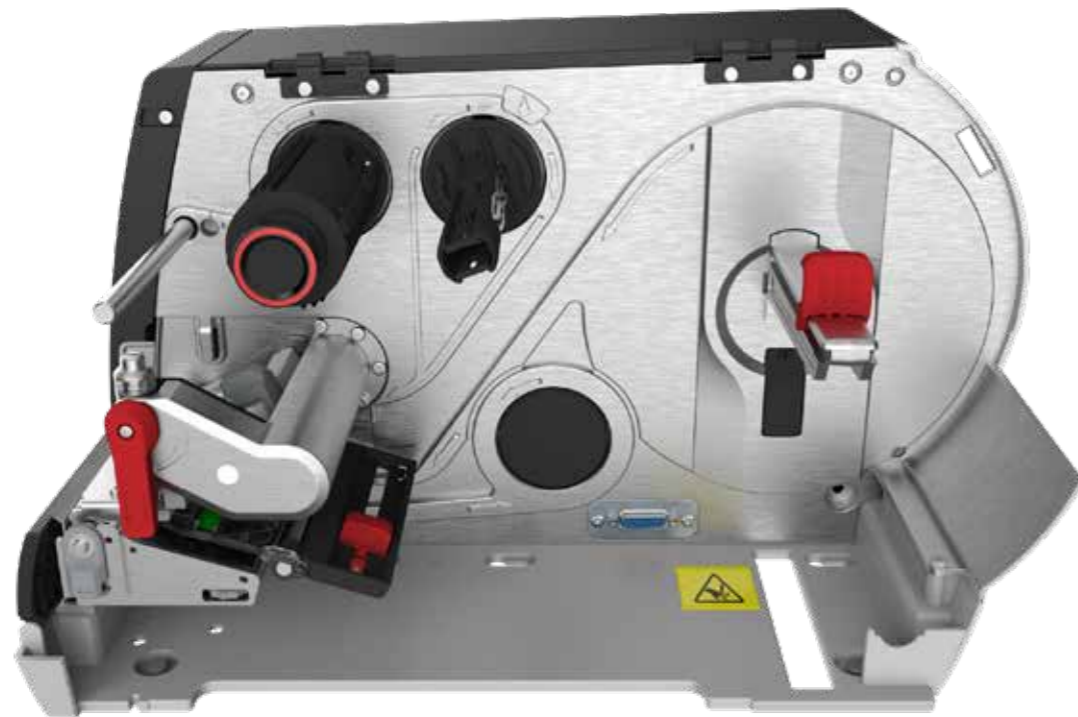

PM45Axxxxxx0xxxx PM45 Tear Off

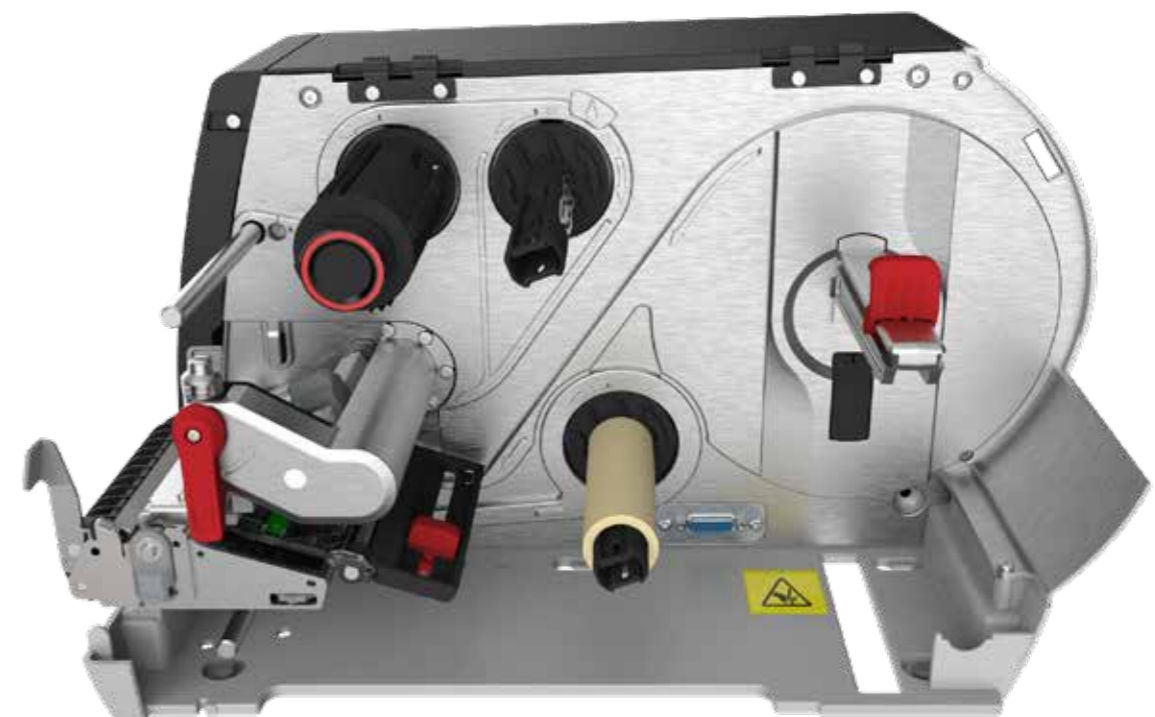

PM45Axxxxxx3xxxx

PM45 with Internal Rewinder + LTS



Label Dispenser

1



Rewinder Shaft



Internal Rewinder

2



Label Taken Sensor

3

	PART NUMBER	DESCRIPTION
1	50180196-001	Label Dispenser, PM45
2	50178326-001	PM45 Rewinder,Media Internal Sub-Assembly
3	715-616S-001	Label Taken Sensor (LTS), Spare Kit, PM43/ PM45

ACCESSORIES

PM45 Full Batch Rewinder

The Full Batch Rewinder is used to pre-print a whole roll of labels and rewind them.

Warning: The Full Batch Rewinder must only be installed by an authorized service technician, as you need to open the printer and physically install the rewinder.



Exploded View

1

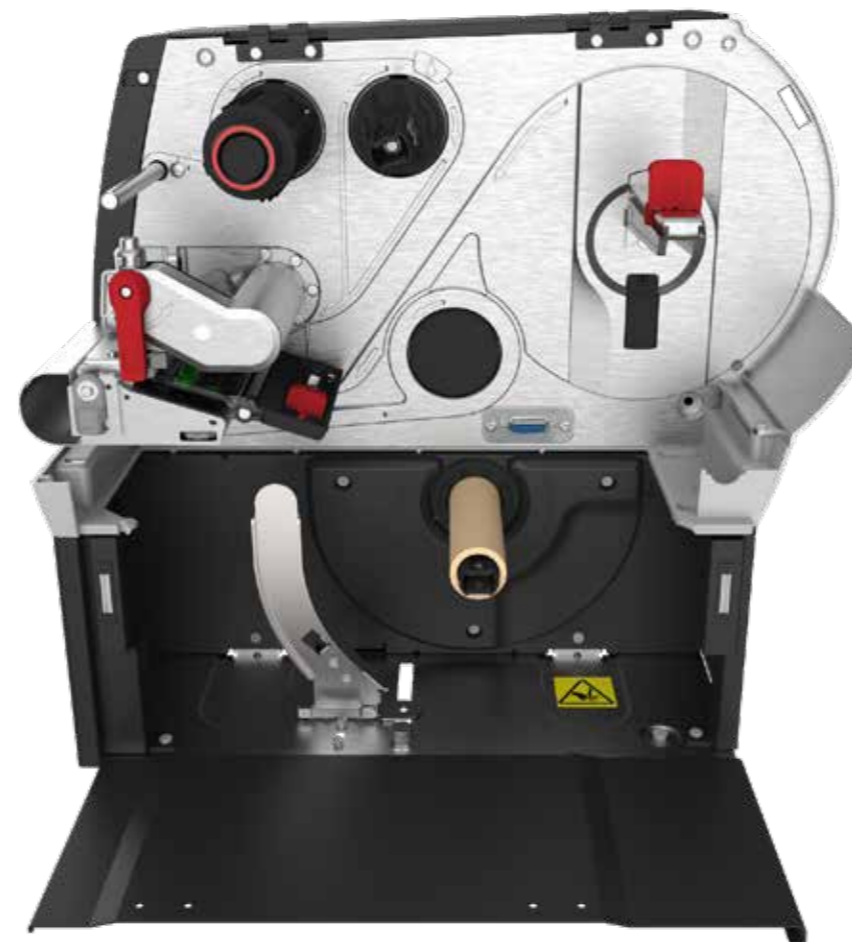

Side View with Empty Core



Side View with Collapsible Core

	PART NUMBER	DESCRIPTION
	50178308-001	KIT, PM45 Full Batch Rewinder (Field option kit)
OPTIONAL	50180221-001	PM45 Collapsible Core

ACCESSORIES

Consumables and Cables



PART NUMBER	DESCRIPTION
50180236-001	PM45/ PM45C 203 DPI Printhead Assembly, 4"
50180237-001	PM45/ PM45C 300 DPI Printhead Assembly, 4"
50180238-001	PM45/ PM45C 406 DPI Printhead Assembly, 4"
50180234-001	PM45/ PM45C 600 DPI Printhead Assembly, 4"



PART NUMBER	DESCRIPTION
321-576-004	USB (USB-A to USB-B) cable, 6.5 ft. (2 m) length



PART NUMBER	DESCRIPTION
1-974024-018	RS-232 (DB9F to DB9M) cable, 5.9 ft. (1.8 m) length



PART NUMBER	DESCRIPTION
50180235-001	Kit, PM45/PM45C Platen Roller



PART NUMBER	DESCRIPTION
1-974022-018	Parallel (IEEE 1284) cable, 5.9 ft. (1.8 m) length



PART NUMBER	DESCRIPTION
1-110501-00	Cleaning Card, 4.5"x6", box of 25

MISCELLANEOUS

AC Cords

Regional Power Cords



PM45 Rear I/O View



AC Power - C13 Type Connector





























PM45C Rear I/O View

PART NUMBER	DESCRIPTION
1-974030-025	AC Power Cord, Australia RoHS
321-501-002	AC Power Cord, Denmark RoHS
1-974027-025FRE	FRE,AC Power Cord, Europe RoHS
321-502-002	AC Power Cord, India/South Africa RoHS
321-471-002	AC Power Cord, Italy RoHS
9000093CABLE	AC POWER CABLE, C14 TYPE, SWITZERLAND 3-PIN
1-974029-020	AC Power Cord, UK RoHS
1-974028-025	AC Power Cord, US RoHS

APPENDIX

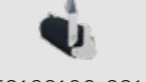
PM45 vs PM43 Accessories

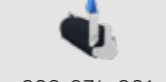
ACCESSORIES									
Category	Description	 PM45	 PM45C	 PM43	 PM43C	Is the PM45 part the same as PM43?	Is the PM43 part compatible with PM45?	Customer Installable	Notes
Platen Roller	Platen Roller Kit	 50180235-001	 50180235-001	 710-118S-001	 710-118S-001	No	No	Yes	New design optimised for PM45 print precision
	Linerless Platen Roller Kit	-	-	203-994-001	203-994-001				No Linerless support on PM45
Printheads	203 DPI Printhead Assembly, 4"	50180236-001	50180236-001	710-129S-001	710-129S-001	No	No	Yes	New design optimised for PM45 print precision
	300 DPI Printhead Assembly, 4"	50180237-001	50180237-001	710-179S-001	710-179S-001	No	No	Yes	New design optimised for PM45 print precision
	406 DPI Printhead Assembly, 4"	50180238-001	50180238-001	710-180S-001	710-180S-001	No	No	Yes	New design optimised for PM45 print precision
	600 DPI Printhead Assembly, 4"	50180234-001	50180234-001	710-129-004FRE	710-129-004FRE	No	No	Yes	New design optimised for PM45 print precision
Collapsible Core	Collapsible Core - Ribbon Take-up	 50174871-001FRE	 50174871-001FRE	 203-971-001	 203-971-001	No	Yes	Yes	PM45 ribbon collapsible core is wider diameter
	Collapsible Core-(Coreless Media) Rewinder	 50180221-001	 50180221-001	 203-971-001	 203-971-001	No	Yes	Yes	Enclosure colour change only
WiFi / Bluetooth	Kit, Wireless LAN, North America (NA)	50178327-001 (a/b/g/n/ac)	50178327-001 (a/b/g/n/ac)	270-189-001 (b/g/n) 270-189-003 (a/b/g/n)	270-189-001 (b/g/n) 270-189-003 (a/b/g/n)	No	No	Yes	
	Kit, Wireless LAN, Rest Of World (ROW)	50174832-001 (a/b/g/n/ac)	50174832-001 (a/b/g/n/ac)	270-189-002 (b/g/n) 270-189-004 (a/b/g/n)	270-189-002 (b/g/n) 270-189-004 (a/b/g/n)	No	No	Yes	
RFID	RFID UHF North America (NA)	50180747-001	50180747-001	270-177-014	270-177-014	No	No	No	Upgrade Kit - Requires authorized technician to install
	RFID UHF Europe (EU) / Rest Of World (ROW)	50180233-001	50180233-001	270-177-005	270-177-005	No	No	No	Upgrade Kit - Requires authorized technician to install
Cutter	Cutter Kit	 50180206-001	 50180201-001	 203-991-002	 203-992-002	No	Yes	Yes (PM45 Only)	Enclosure colour change only
Interface Boards	Applicator	PM45-APPL-01	PM45-APPL-01	-	-	No	No	No	Upgrade Kit - Requires authorized technician to install
	DUART Industrial Interface Card	-	-	270-191-001	270-191-001	No	No	No	Upgrade Kit - Requires authorized technician to install
	Industrial Interface Board	PM45-IND-01	PM45-IND-01	270-192-001	270-192-001	No	No	No	Upgrade Kit - Requires authorized technician to install
	Parallel Port Card	PM45-PAR-01	PM45-PAR-01	270-188-001	270-188-001	No	No	No	Upgrade Kit - Requires authorized technician to install
	USB Hub Interface Card	-	-	270-190-001	270-190-001	No	No	No	Upgrade Kit - Requires authorized technician to install
WWAN 4G LTE	50179990-001	50179990-001	-	-	No	No	No	Upgrade Kit - Requires authorized technician to install	
Media Supply Options	3" Media Core	203-972-001	203-972-001	203-972-001	203-972-001	Yes	Yes	Yes	
	Rotation Hanger Kit	203-977-001	203-977-001	203-977-001	203-977-001	Yes	Yes	Yes	
	Large Media Arm Edge Guide	 50180192-001	 50180192-001	 203-973-001	 203-973-001	No	Yes	Yes	Colour change only
Label Dispenser	Label Dispenser	 50180196-001	 50180196-001	 203-974-001	 203-974-001	No	Yes	Yes	Colour change only
Rewinder	Internal Rewinder/Peel Off Kit	50178326-001	50178326-001	710-090S-001	710-090S-001	No	Yes	No	Colour change only
	Full Roll Rewinder (Full Batch) Kit	50178308-001	-	203-976-001	-	No	Yes	No	Colour change only
Media Lock	Media Lock	-	-	203-970-001	-	-	-	-	Not supported on PM45

APPENDIX

Front Display - Compare PM45 to PM43

Compare the LCD/ Keyboard assembly.



PM43



PM45

APPENDIX

Media Compartment - Compare PM45 to PM43

Compare the media setup.



PM43

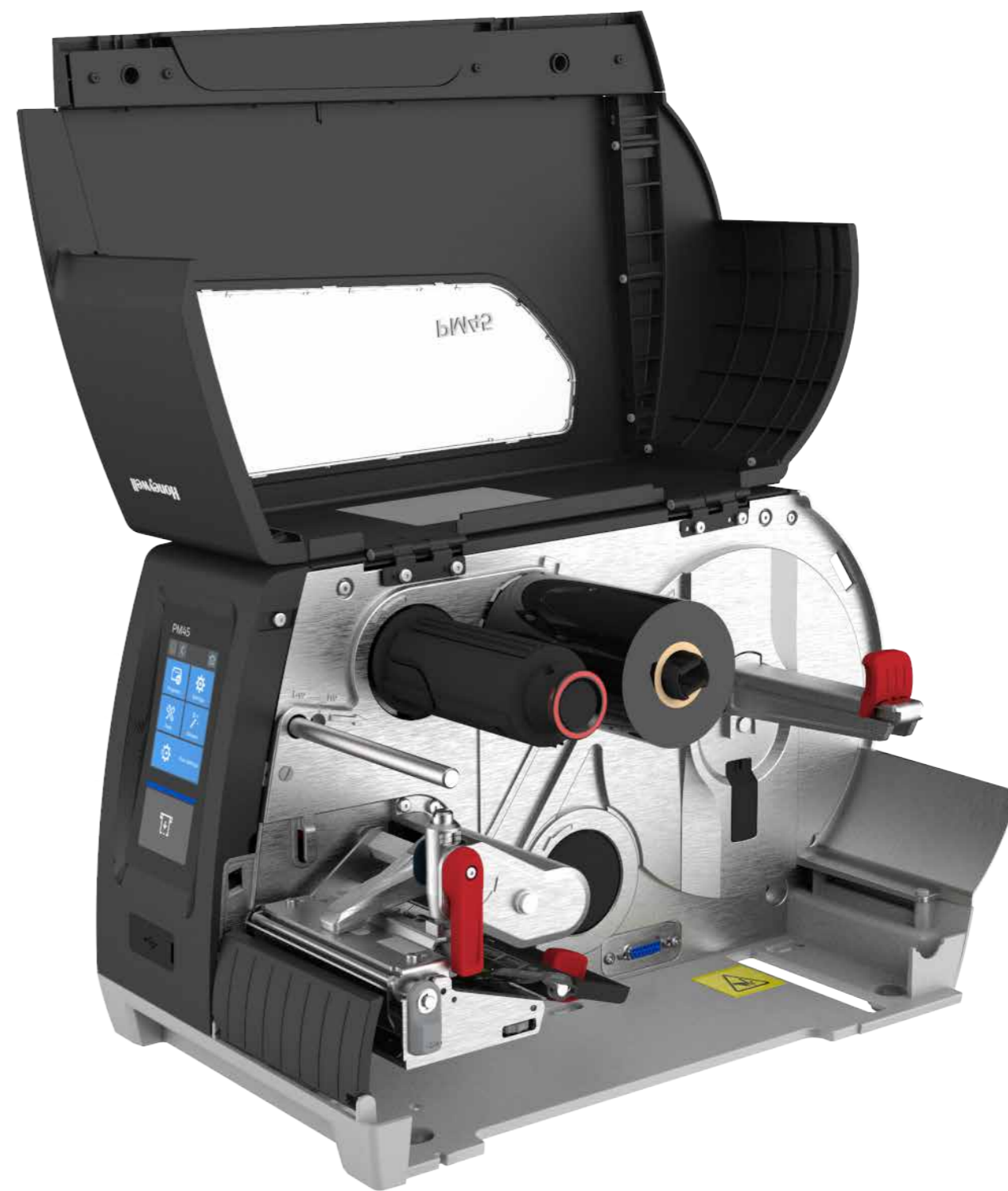

PM45

APPENDIX

Connectivity - Compare PM45 to PM43

Compare the previous communication ports.



PM43



PM45

MISCELLANEOUS

Disclaimer

Disclaimer

Honeywell International Inc. ("HII") reserves the right to make changes in specification and other information contained in this document without prior notice, and the reader should in all cases consult HII to determine whether any such changes have been made. The information in this publication does not represent a commitment on the part of HII.

HII shall not be liable for technical or editorial errors or omissions contained herein; nor for incidental or consequential damages resulting the furnishing, performance, or use of this material.

This document contains proprietary information that is protected by copyright. All rights are reserved. No part of this document may be photocopied, reproduced, or translated into another language with-out prior written consent of HII.

Web Address: www.honeywellaidc.com

The Bluetooth trademarks are owned by Bluetooth SIG, Inc., U.S.A and licensed to Honeywell.

Other product names mentioned in the manual may be trademarks of registered trademarks of their respective companies and are the property of their respective owners.

All rights reserved.

For more information

sps.honeywell.com

Honeywell Safety and Productivity Solutions

300 S Tryon St Suite 500
Charlotte, NC 28202
800-582-4263
www.honeywell.com